

ConMed Endoscopic Technologies

Ordering Information, Customer Service 800-448-6506

CONMED ENDOSCOPIC TECHNOLOGIES

ORDERING INFORMATION, CUSTOMER SERVICE 800-448-6506

CONMED



AXCESS™
Multi-Directional Papillotome

Take Control,
Gain Access



GORE VIABIL™
BILIARY
ENDOPROSTHESIS
FOR THE TREATMENT OF
MALIGNANT BILIARY STRICTURES

A Revolutionary
Biliary Stent



**BiCap Superconductor™
Probe**

Superior Contact
and Conductivity



BEAMER™
SYSTEM CE600



Auto-Band

Visualize.
Deploy.
Rely.

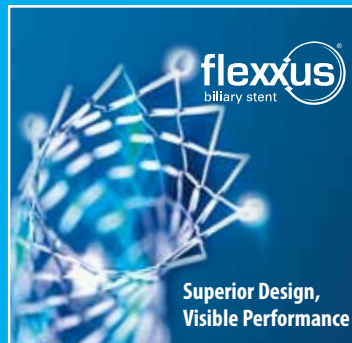

flexxus®
biliary stent

Superior Design,
Visible Performance



NAKAO SPIDER-NET™
RETRIEVAL DEVICE

Inspired by Nature
to Capture and Retrieve

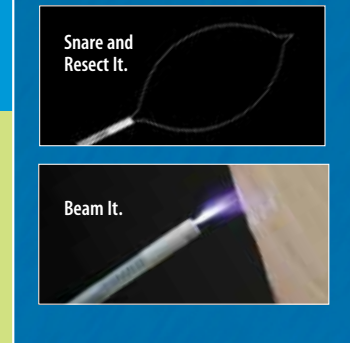

Snare and
Resect It.

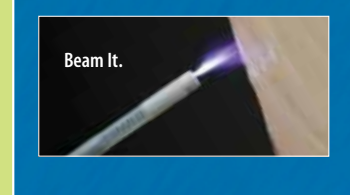

Beam It.

Applied Ingenuity™

CONMED™
ENDOSCOPIC TECHNOLOGIES



MISSION STATEMENT

ConMed Endoscopic Technologies focuses on proprietary, differentiated, technologically advanced diagnostic and therapeutic Endoscopic products. We don't play "follow the leader". We lead by solving the real clinical challenge.

TABLE OF CONTENTS

ORDERING INFORMATION

Ordering Information 1



BILIARY

Papillotomes

Access™ Multi-Directional Pillotome	3
Apollo 3AC® Advanced Cannulation Triple Lumen Papillotomes	3
Apollo 3® Tapered Tip Triple Lumen Papillotomes	3
Apollo 3® Beveled Tip Triple Lumen Papillotomes	3
Apollo AC® Advanced Cannulation Double Lumen Papillotomes	4
Apollo® Tapered Tip Double Lumen Papillotomes	4
Apollo® Beveled Tip Double Lumen Papillotomes	4

Guidewires

FXWire® Advanced Measurement Guidewire	5
Director™ Guidewire System	5
XWire® Guidewire	6

Cannulae

ProForma® HF 4.5 Cannula	7
ProForma® Cannula	7

Stone Removal Balloons

DuraGlide™ Triple Lumen Stone Removal Balloons	8
DuraGlide™ Double Lumen Stone Removal Balloons	8

Dilation Balloons

Eliminator® PET Biliary Balloon Dilators	9
--	---

Plastic Stents

Hydroduct® Biliary Stents	10 – 13
---------------------------	---------

Metal Stents

Gore Viabil® Biliary Endoprosthesis	14
Flexxus® Endoscopic Biliary Stent	15



ENDOSCOPIC ULTRASOUND

Fine Needle Aspiration

Vizeon® Endoscopic Ultrasound Needle	17
--------------------------------------	----



DILATION

Disposable PET Balloon Dilators

Eliminator® PET Balloon Dilators	19
ConMed® Balloon Inflation Device Multi-Stage Inflation Pressures	19

Reusable Polyvinyl Dilators

American Dilation System	20
--------------------------	----



HEMOSTASIS

Ligation Devices

Auto-Band Ligator	21
-------------------	----

Ligation Devices

Stiegmann-Goff™ Endoscopic Ligator Kit	22
ConMed® Endoscopic Overtube	22

Ligation Devices

Stiegmann-Goff™ Bandito™ Endoscopic Ligator	23
---	----

Disposable Injection Needles

Sure Shot® Metal Sheathed Injection Needle	24
Click-Tip™ Injection Needle	24
Flexitip™ Disposable Sclerotherapy Needles	24

Hemostasis Probes

BiCap Superconductor™ Multi-electrode Bipolar Probes	25
Beamer™ Argon Snare Probe	25
Beamer™ Argon Probe	25

Bipolar Probes

Coaxial Bipolar Adaptors * For use with Everest™ and ValleyLab™ Force2™ Generators	26
--	----

Bipolar/Monopolar Generator

Beamer™ System CE600	27
Beamer™ Irrigation Pump	27
Accessories for Beamer™ Irrigation Pump	27



BIOPSY

Disposable Biopsy Forceps 29

Optibite™ Disposable Biopsy Forceps	29
Precisor® EXL™ Coated Disposable Biopsy Forceps	29
Pediatric GI Precisor® Disposable Biopsy Forceps	30
Precisor® Hot Disposable Biopsy Forceps	31
Precisor Broncho® Disposable Biopsy Forceps	31

Disposable Percutaneous Biopsy Instrument

Monopty® Percutaneous Biopsy Instrument Kits	32
--	----

Disposable GI Cytology Brushes

ConMed® Cytology Brushes	33
Cytology Brushes	33

TABLE OF CONTENTS



GASTROSTOMY

Gastrostomy Feeding Systems	
EnTake™ PEG System	35
Replacement Gastrostomy Tube (G-Tube)	
EnTake™ Tri-Funnel Replacement G-Tube	36
Jejunum Feeding Tubes	
EnTake™ J-Tube Feeding Tubes	36



POLYPECTOMY

Specimen Devices	
Nakao Spider-Net™ Retrieval Devices	37
Beamer Argon Snare Probe	37
Beamer Argon Probe	37
Optimizer® Multi-Chamber Polyp Trap	37
Disposable Snares	
Orbit-Snare™ Rotatable	
Polypectomy Snares	38
Optimizer® Polypectomy Snares	38
Active Cord	38
Singular™ Polypectomy Snares	39
Disposable Snare Assembly	
To Fit Olympus® Handle	40
Disposable Snare Assembly	
To Fit Cameron-Miller™ Handle	40
Disposable Snare Assembly	
ConMed® Handle	40

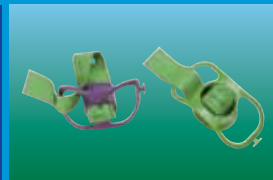

ACCESSORIES

Cleaning Brushes	
Channel Master™ Endoscope	
Cleaning Brushes	41
Whistle® Endoscope Cleaning Brush	41
Blue Bullet® Disposable Cleaning Brushes	41
Reusable Cleaning Brush	41
Accessory Devices	
Scope Saver® Disposable Bite Blocks	42
Biopsy Channel Accessory Introducer	42
Bite Block	42

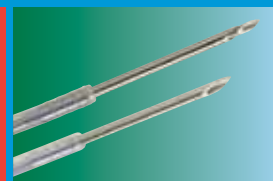

PULMONARY

Transbronchial Aspiration Needles	
WANG® Cytology Needles	43
WANG® Histology Needles	43
Biopsy Forceps	
Precisor Broncho®	
Disposable Biopsy Forceps	44
Brushes	
Cytology Brushes	45
Needle Tip and Peripheral	
Cytology Brushes	46
Microbiology Brush	46
Kits and Accessories	
WANG® Pleural Tapping Needle	47
GARG™ Thoracentesis Needle and Kit	48
Cleaning Brushes	
Blue Bullet® Disposable Cleaning Brush	49
Channel Master™ Endoscope	
Cleaning Brush	49
Reusable Cleaning Brush	49



GENERATORS

Generators	
Beamer® System CE600	51
Beamer™ Irrigation Pump	51
Accessories for Beamer™	
Irrigation Pump	51
Beamer™ Argon Snare Probe	52
Beamer™ Argon Probe	52

LATEX PRODUCTS 53

CATALOG NUMBER INDEX 55 – 58

ORDERING INFORMATION

ORDERING INFORMATION



Applied Ingenuity™



ORDERING INFORMATION

To Place Your Order

Please provide a purchase order number, billing and shipping instructions, terms, product catalog number and description and pricing to:

Customer Service if calling from within the U.S.

Customer Support

If you encounter a problem or need technical assistance, contact your ConMED Sales Representative or Customer Service. Refer to the Customer Service telephone numbers listed below.

Customer Service (Within U.S.)

Telephone: (800) 448-6506

Fax: (800) 438-3051

International Customer Service

Telephone: +1(315) 797-8375

Fax: +1(315) 735-6235

If you are not sure which ConMed Business Unit carries the product you would like to order, please call ConMed Customer Service for Assistance.

A Customer Service Representative will direct you to one of these ConMed Business Units:

- ConMed Arthroscopy
- ConMed Electrosurgery
- ConMed Endoscopic Technologies
- ConMed Endoscopy
- ConMed EndoSurgery
- ConMed Integrated Systems
- ConMed Linvatec
- ConMed Patient Care
- ConMed Powered Instruments

Terms and Conditions

All prices and specifications are subject to change without notice. All prices are F.O.B. Utica, New York; Centennial, Colorado; Lithia Springs, Georgia, (F.O.B. Drop Shipment Points where applicable). Purchase orders should be addressed to ConMed Corporation, 525 French Road, Utica, NY 13502.

CREDIT TERMS: Net 30 days.

Return Goods Policy

All ConMED products, except products that are obsolete, discontinued, or damaged and specialty products, may be returned within 60 days after date of purchase for credit subject to the following:

1. A copy of the invoice number and date of purchase and a Return Authorization Number must accompany the returned goods with the reason for the return stated in writing. Contact ConMED Customer Service for the Return Authorization Number at 1-800-448-6506.
2. All returned goods would be subject to a minimum of 15% restocking charge. The exact amount of credit to be given, if any, will be determined by a Quality Assurance inspection. Sterile packaged products may be returned for credit only if returned in the original, unopened shelf package.
3. If the return is due to our error in shipping, full credit will be given.
4. All returns should be addressed as indicated by Return Authorization.

Scheduled Shipments

To help maximize the efficiency of your ordering process and inventory control, we offer scheduled shipments.

- The advantages include:
- regular delivery schedule
 - one purchase order per year
 - favorable pricing
 - price protection
 - free freight for Federal Express Economy Delivery

Quality Policy

All ConMed products are manufactured and produced in compliance with the following quality system standards:

- 21 CFR 820, US FDA Quality System Regulation
- ISO 13485
- European MDD

All Products may not be available for sale in your region.

For information on pricing and product availability, please contact your local ConMED representative.

BILIARY

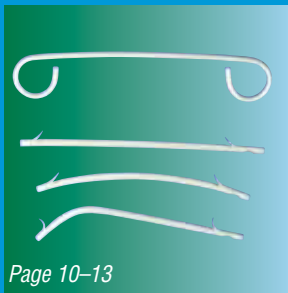

Page 10-13



Page 8

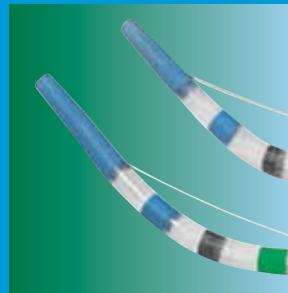

Page 6

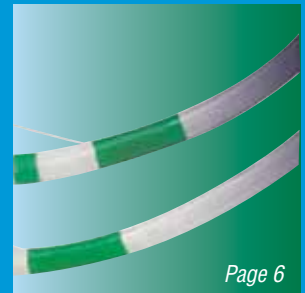

Page 3

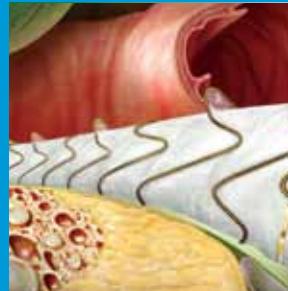

Page 9

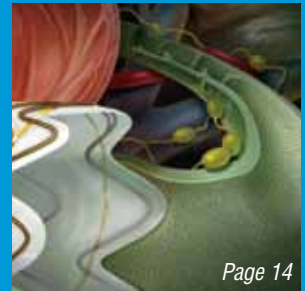

Page 14

Papillotomes

<i>Access™ Multi-Directional Pillotome</i>	3
<i>Apollo 3AC® Advanced Cannulation</i>	
<i>Triple Lumen Papillotomes</i>	3
<i>Apollo 3® Tapered Tip</i>	
<i>Triple Lumen Papillotomes</i>	3
<i>Apollo 3® Beveled Tip</i>	
<i>Triple Lumen Papillotomes</i>	3
<i>Apollo AC® Advanced Cannulation</i>	
<i>Double Lumen Papillotomes</i>	4
<i>Apollo® Tapered Tip</i>	
<i>Double Lumen Papillotomes</i>	4
<i>Apollo® Beveled Tip</i>	
<i>Double Lumen Papillotomes</i>	4



Page 15



Guidewires

<i>FXWire® Advanced</i>	
<i>Measurement Guidewire</i>	5
<i>Director™ Guidewire System</i>	5
<i>XWire® Guidewire</i>	6

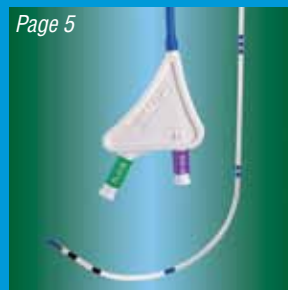

Page 5



Cannulae

<i>ProForma® HF 4.5 Cannula</i>	7
<i>ProForma® Cannula</i>	7

Stone Removal Balloons

<i>DuraGlide™ Triple Lumen</i>	
<i>Stone Removal Balloons</i>	8
<i>DuraGlide™ Double Lumen</i>	
<i>Stone Removal Balloons</i>	8

Dilation Balloons

<i>Eliminator® PET Biliary Balloon Dilators</i>	9
---	---

Plastic Stents

<i>Hydroduct® Biliary Stents</i>	10 - 13
----------------------------------	---------

Metal Stents

<i>Gore Viabil® Biliary Endoprosthesis</i>	14
<i>Flexxus® Endoscopic Biliary Stent</i>	15



Papillotomes



Access™ Multi-Directional Papillotome

Sterile, Disposable

Catalog Number	Tip O.D.	Cutting Wire		Catheter		Guidewire		Unit
		Length	Type	Length	O.D.	Compatibility		
AX4535	4.5 F	22.5mm	Monofilament	190cm	7-4.5 F	.035"/.89mm		3/Box

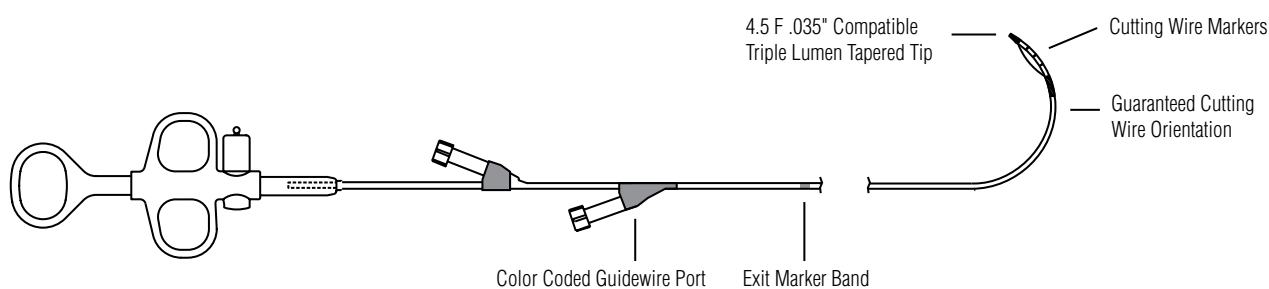

Apollo 3AC® Advanced Cannulation Triple Lumen Papillotomes

Latex **FREE**

Sterile, Disposable

Catalog Number	Type	Tip		Cutting Wire		Catheter		Guidewire	
		Length	O.D.	Length	Type	Length	O.D.	Compatibility	Unit
7104AC	Short Nose	5mm	4.5 F	20mm	Monofilament	190cm	7-4.5 F	.035"/.89mm	1/Box
7105AC	Short Nose	5mm	4.5 F	30mm	Monofilament	190cm	7-4.5 F	.035"/.89mm	1/Box

Apollo 3® Tapered Tip Triple Lumen Papillotomes

Latex **FREE**

Sterile, Disposable

Catalog Number	Type	Tip		Cutting Wire		Catheter		Guidewire	
		Length	O.D.	Length	Type	Length	O.D.	Compatibility	Unit
007104	Short Nose	8mm	5.0 F	20mm	Monofilament	190cm	7-5.0 F	.035"/.89mm	1/Box
007105	Short Nose	8mm	5.0 F	30mm	Monofilament	190cm	7-5.0 F	.035"/.89mm	1/Box
007106	Long Nose	20mm	5.0 F	20mm	Monofilament	190cm	7-5.0 F	.035"/.89mm	1/Box
007107	Long Nose	20mm	5.0 F	30mm	Monofilament	190cm	7-5.0 F	.035"/.89mm	1/Box

Apollo 3® Beveled Tip Triple Lumen Papillotomes

Latex **FREE**

Sterile, Disposable

Catalog Number	Type	Tip		Cutting Wire		Catheter		Guidewire	
		Length	O.D.	Length	Type	Length	O.D.	Compatibility	Unit
050071	Short Nose	8mm	5.5 F	20mm	Monofilament	190cm	7-5.5 F	.035"/.89mm	1/Box
050073	Short Nose	8mm	5.5 F	30mm	Monofilament	190cm	7-5.5 F	.035"/.89mm	1/Box

All Apollo® Papillotomes accommodate an Olympus® active cord.

Papillotomes

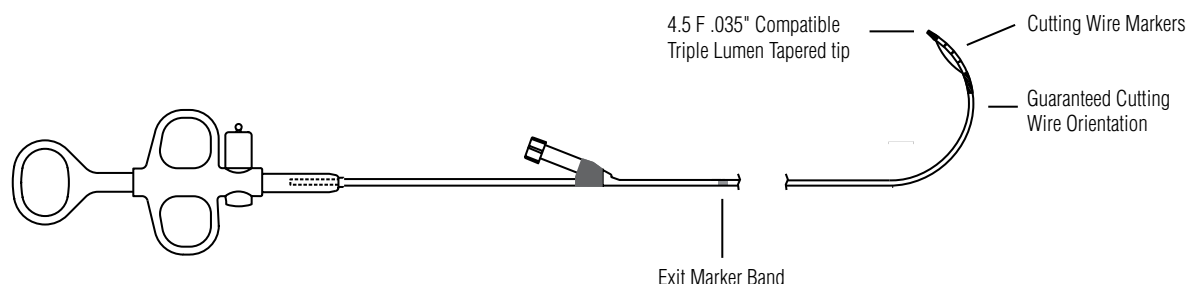

Apollo AC® Advanced Cannulation Double Lumen Papillotomes

Latex **FREE**

Sterile, Disposable

Catalog Number	Type	Tip		Cutting Wire		Catheter		Guidewire	
		Length	O.D.	Length	Type	Length	O.D.	Compatibility	Unit
7100AC	Short Nose	5mm	4.5 F	20mm	Monofilament	190cm	7-4.5 F	.035"/.89mm	1/box
7101AC	Short Nose	5mm	4.5 F	30mm	Monofilament	190cm	7-4.5 F	.035"/.89mm	1/box

Apollo® Tapered Tip Double Lumen Papillotomes

Latex **FREE**

Sterile, Disposable

Catalog Number	Type	Tip		Cutting Wire		Catheter		Guidewire	
		Length	O.D.	Length	Type	Length	O.D.	Compatibility	Unit
007100	Short Nose	8mm	5.0 F	20mm	Monofilament	190cm	7-5.0 F	.035"/.89mm	1/box
007101	Short Nose	8mm	5.0 F	30mm	Monofilament	190cm	7-5.0 F	.035"/.89mm	1/box
007102	Long Nose	20mm	5.0 F	20mm	Monofilament	190cm	7-5.0 F	.035"/.89mm	1/box
007103	Long Nose	20mm	5.0 F	30mm	Monofilament	190cm	7-5.0 F	.035"/.89mm	1/box

Apollo® Beveled Tip Double Lumen Papillotomes

Latex **FREE**

Sterile, Disposable

Catalog Number	Type	Tip		Cutting Wire		Catheter		Guidewire	
		Length	O.D.	Length	Type	Length	O.D.	Compatibility	Unit
050053	Short Nose	8mm	5.5 F	20mm	Braided	190cm	7-5.5 F	.035"/.89mm	1/box
050054	Short Nose	8mm	5.5 F	30mm	Braided	190cm	7-5.5 F	.035"/.89mm	1/box
050063	Short Nose	8mm	5.5 F	20mm	Monofilament	190cm	7-5.5 F	.035"/.89mm	1/box
050064	Short Nose	8mm	5.5 F	30mm	Monofilament	190cm	7-5.5 F	.035"/.89mm	1/box

All Apollo® Papillotomes accommodate an Olympus® active cord.

■ Guidewires

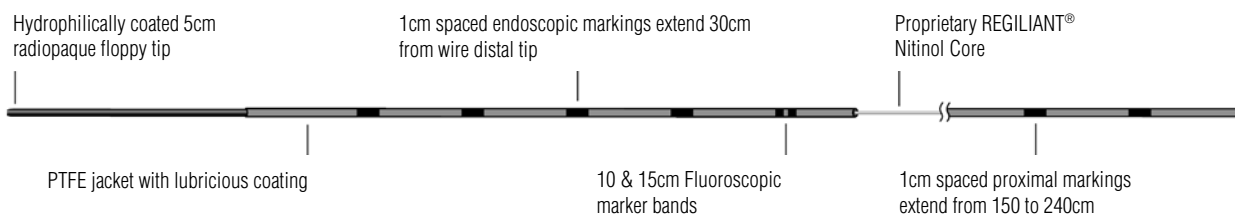

FXWire[®] Advanced Measurement Guidewire

Latex **FREE**

Sterile, Disposable

Catalog Number	Description	Guidewire O.D.		Length	Tip Type	Torque	
		Inches	Millimeters			Vise	Unit
FX35450S	Standard Wire	.035"	.89mm	450cm	Straight Tip	No	3/Box
FX35450A	Standard Wire	.035"	.89mm	450cm	Torqueable Angled Tip	Yes	3/Box
FX35260S	Standard Wire	.035"	.89mm	260cm	Straight Tip	No	3/Box
FX35260A	Standard Wire	.035"	.89mm	260cm	Torqueable Angled Tip	Yes	3/Box

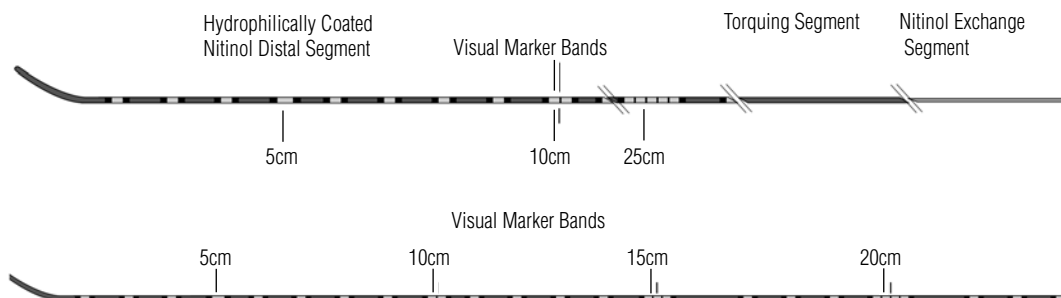

Director[™] Guidewire System

Latex **FREE**

Sterile, Disposable

Catalog Number	Description	Tip O.D.	Unit
000560	.035", Torqueable Angled Tip, 480cm	.027"/.67mm	3/Box

■ Guidewires

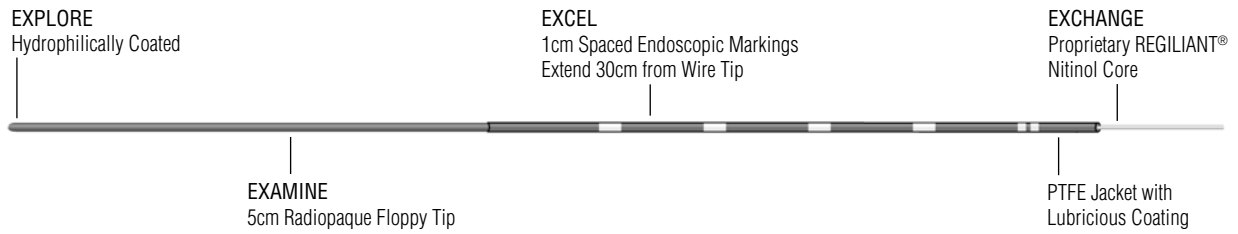

XWire® Guidewire

Latex **FREE**

Sterile, Disposable

Catalog Number	Description	Guidewire O.D.		Length	Tip Type	Torque	
		Inches	Millimeters			Vise	Unit
035450S	Standard Wire	.035"	.89mm	450cm	Straight Tip	No	3/Box
035450A	Standard Wire	.035"	.89mm	450cm	Torquable Angled Tip	Yes	3/Box
035260S	Standard Wire	.035"	.89mm	260cm	Straight Tip	No	3/Box
035260A	Standard Wire	.035"	.89mm	260cm	Torquable Angled Tip	Yes	3/Box
035450SS	Stiff Wire	.035"	.89mm	450cm	Straight Tip	No	3/Box
035450AS	Stiff Wire	.035"	.89mm	450cm	Torquable Angled Tip	Yes	3/Box
035260SS	Stiff Wire	.035"	.89mm	260cm	Straight Tip	No	3/Box
035260AS	Stiff Wire	.035"	.89mm	260cm	Torquable Angled Tip	Yes	3/Box
025450S	Standard Wire	.025"	.64mm	450cm	Straight Tip	No	3/Box
025450A	Standard Wire	.025"	.64mm	450cm	Torquable Angled Tip	Yes	3/Box
025260S	Standard Wire	.025"	.64mm	260cm	Straight Tip	No	3/Box

■ Cannulae



ProForma® HF 4.5 Cannula

Latex **FREE**

Sterile, Disposable

Catalog Number	Tip	Tip O.D.	Catheter O.D.	Length	Guidewire Compatibility	Unit
Precurved						
050907	Curved Taper Tip	4.5 F/1.5mm	7-5 F/1.7mm	190cm	.035"/.89mm	5/Box
050906	Straight Taper Tip	4.5 F/1.5mm	7-5 F/1.7mm	190cm	.035"/.89mm	5/Box

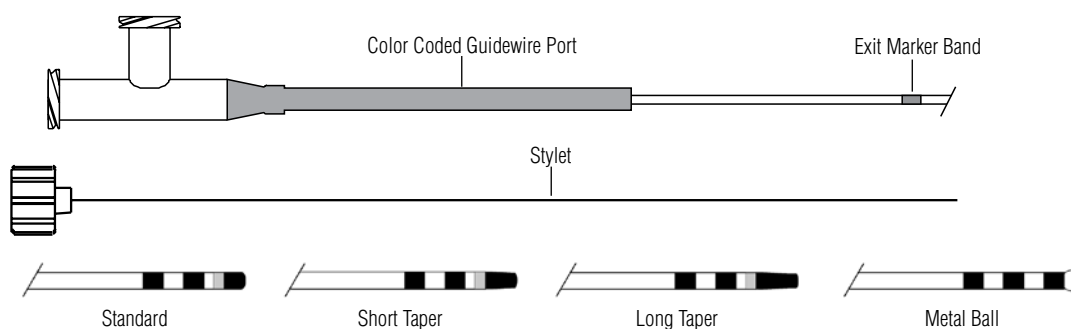

ProForma® Cannula

Latex **FREE**

Sterile, Disposable

Catalog Number	Tip	Tip O.D.	Catheter O.D.	Length	Guidewire Compatibility	Unit
Precurved						
050310	Standard Tip	5.0 F/1.7mm	5.0 F/1.7mm	200cm	.035"/.89mm	3/Box
050320	Long Taper	4.5 F/1.5mm	5.0 F/1.7mm	200cm	.035"/.89mm	3/Box
050330	Short Taper	4.5 F/1.5mm	5.0 F/1.7mm	200cm	.035"/.89mm	3/Box
050370	Metal Ball	5.5 F/1.8mm	5.0 F/1.7mm	200cm	.035"/.89mm	3/Box
Straight						
050300	Standard Tip	5.0 F/1.7mm	5.0 F/1.7mm	200cm	.035"/.89mm	3/Box
050315	Long Taper	4.5 F/1.5mm	5.0 F/1.7mm	200cm	.035"/.89mm	3/Box
050325	Short Taper	4.5 F/1.5mm	5.0 F/1.7mm	200cm	.035"/.89mm	3/Box
Non-Sterile, Disposable						
Ultra Tapered						
000156	Tapered, Ultra	4.0 F/1.3mm	5.5 F/1.8mm	200cm	.025"/.64mm	2/Box
000183	Tapered, 5-4-3	3.5 F/1.2mm	5.5 F/1.8mm	200cm	.018"/.46mm	2/Box

Stone Removal Balloons

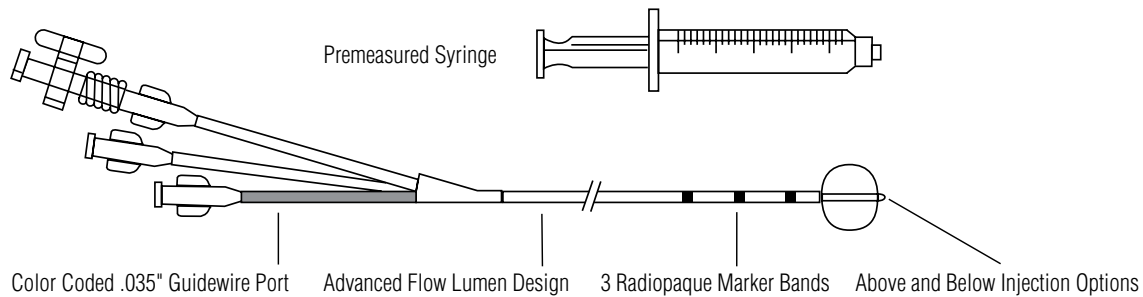

DuraGlide™ Triple Lumen Stone Removal Balloons

Sterile, Disposable

Catalog Number	Balloon		Catheter		Guidewire Compatibility	Unit
	O.D.	Volume	O.D.	Length		
Injection Above Balloon						
007123	8.5mm	.75 cc	7-5 F/2.3-1.7mm	200cm	.035"/.89mm	1/Box
007124	11.5mm	1.5 cc	7-5 F/2.3-1.7mm	200cm	.035"/.89mm	1/Box
007125	15.0mm	3.5 cc	7-5 F/2.3-1.7mm	200cm	.035"/.89mm	1/Box
Injection Below Balloon						
007143	8.5mm	.75 cc	7-5 F/2.3-1.7mm	200cm	.035"/.89mm	1/Box
007144	11.5mm	1.5 cc	7-5 F/2.3-1.7mm	200cm	.035"/.89mm	1/Box
007145	15.0mm	3.5 cc	7-5 F/2.3-1.7mm	200cm	.035"/.89mm	1/Box

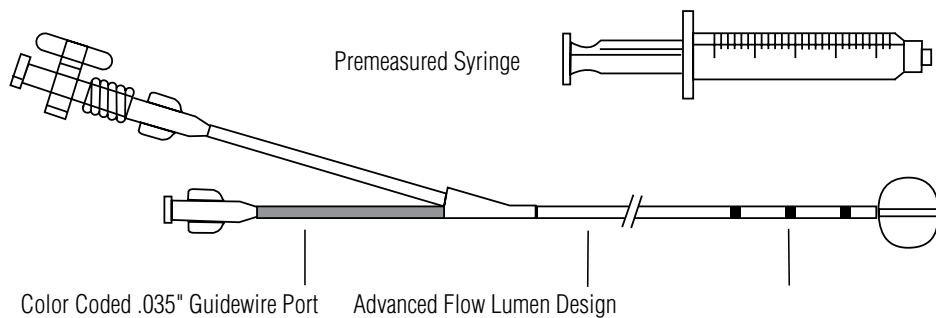

DuraGlide™ Double Lumen Stone Removal Balloons

Sterile, Disposable

Catalog Number	Balloon		Catheter		Guidewire Compatibility	Unit
	O.D.	Volume	O.D.	Length		
Standard						
000637	11.5mm	1.5 cc	7 F/2.3mm	200cm	.035"/.89mm	1/Box
000638	15.0mm	3.5 cc	7 F/2.3mm	200cm	.035"/.89mm	1/Box
Tapered						
000635	8.5mm	.75 cc	7-5 F/2.3-1.7mm	200cm	.035"/.89mm	1/Box
000646	11.5mm	1.5 cc	7-5 F/2.3-1.7mm	200cm	.035"/.89mm	1/Box
000647	15.0mm	3.5 cc	7-5 F/2.3-1.7mm	200cm	.035"/.89mm	1/Box

■ Dilation Balloons

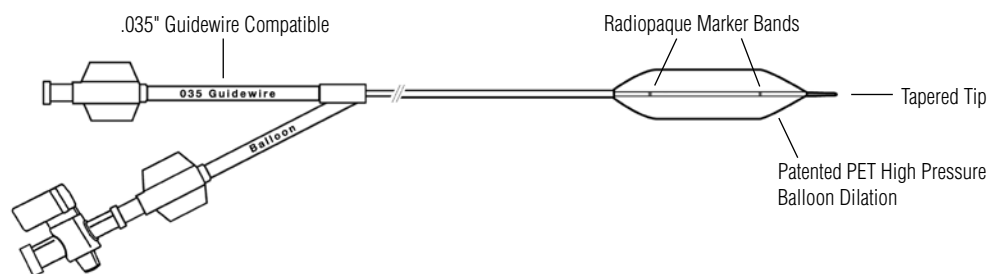

Eliminator® PET Biliary Balloon Dilators

Latex **FREE**

Sterile, Disposable

Catalog Number	Description	Balloon Inflation		Catheter		Guidewire	
		Pressure	Length	O.D.	Length	Compatibility	Unit
000347	4mm x 2cm	150 psi/10.2 atm	2cm	5 F/1.7mm	180cm	.035"/.89mm	1/Box
000348	6mm x 2cm	150 psi/10.2 atm	2cm	5 F/1.7mm	180cm	.035"/.89mm	1/Box
000349	8mm x 3cm	120 psi/8.2 atm	3cm	5 F/1.7mm	180cm	.035"/.89mm	1/Box

Plastic Stents

ANGLED STENT



Hydroduct® Biliary Stents

Latex **FREE***Sterile, Disposable*

Catalog Number	Description	Stent O.D.	Length	Unit
00705A	Single Stent	7 F	5cm	1/Box
00707A	Single Stent	7 F	7cm	1/Box
00709A	Single Stent	7 F	9cm	1/Box
00712A	Single Stent	7 F	12cm	1/Box
00715A	Single Stent	7 F	15cm	1/Box
01005A	Single Stent	10 F	5cm	1/Box
01007A	Single Stent	10 F	7cm	1/Box
01009A	Single Stent	10 F	9cm	1/Box
01012A	Single Stent	10 F	12cm	1/Box
01015A	Single Stent	10 F	15cm	1/Box
01205A	Single Stent	12 F	5cm	1/Box
01207A	Single Stent	12 F	7cm	1/Box
01209A	Single Stent	12 F	9cm	1/Box
01212A	Single Stent	12 F	12cm	1/Box
01215A	Single Stent	12 F	15cm	1/Box
0705AK	Pre-Loaded Stent Kit *	7 F	5cm	1/Box
0707AK	Pre-Loaded Stent Kit *	7 F	7cm	1/Box
0709AK	Pre-Loaded Stent Kit *	7 F	9cm	1/Box
0712AK	Pre-Loaded Stent Kit *	7 F	12cm	1/Box
0715AK	Pre-Loaded Stent Kit *	7 F	15cm	1/Box
1005AK	Pre-Loaded Stent Kit	10 F	5cm	1/Box
1007AK	Pre-Loaded Stent Kit	10 F	7cm	1/Box
1009AK	Pre-Loaded Stent Kit	10 F	9cm	1/Box
1012AK	Pre-Loaded Stent Kit	10 F	12cm	1/Box
1015AK	Pre-Loaded Stent Kit	10 F	15cm	1/Box
1205AK	Pre-Loaded Stent Kit	12 F	5cm	1/Box
1207AK	Pre-Loaded Stent Kit	12 F	7cm	1/Box
1209AK	Pre-Loaded Stent Kit	12 F	9cm	1/Box
1212AK	Pre-Loaded Stent Kit	12 F	12cm	1/Box
1215AK	Pre-Loaded Stent Kit	12 F	15cm	1/Box

* All 7 F Kits Contain Push Catheter Only

Each Pre-Loaded Stent Kit Includes:

- 1 ea. Stent
- 1 ea. Guide Catheter
- 1 ea. Push Catheter

PUSH CATHETER AND GUIDE CATHETER



Catalog Number	Description	Push Catheter	Unit
0700G	Stent Introducer Kit * ◊	7 F	1/Box
1006L	Pre-Loaded Stent Introducer Kit ◊	10 F	1/Box
1206L	Pre-Loaded Stent Introducer Kit ◊	12 F	1/Box

Each Pre-Loaded Stent Introducer Kit Includes:

- 1 ea. Guide Catheter
- 1 ea. Push Catheter

* All 7 F Introducer Kits Contain Push Catheter Only

◊ Stent Sold Separately

■ Plastic Stents

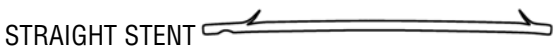

Hydroduct® Biliary Stents

Latex **FREE**

Sterile, Disposable

Catalog Number	Description	Stent O.D.	Length	Unit
00705S	Single Stent	7 F	5cm	1/Box
00707S	Single Stent	7 F	7cm	1/Box
00710S	Single Stent	7 F	10cm	1/Box
01005S	Single Stent	10 F	5cm	1/Box
01007S	Single Stent	10 F	7cm	1/Box
01010S	Single Stent	10 F	10cm	1/Box
01205S	Single Stent	12 F	5cm	1/Box
01207S	Single Stent	12 F	7cm	1/Box
01210S	Single Stent	12 F	10cm	1/Box
0705SK	Pre-Loaded Stent Kit *	7 F	5cm	1/Box
0707SK	Pre-Loaded Stent Kit *	7 F	7cm	1/Box
0710SK	Pre-Loaded Stent Kit *	7 F	10cm	1/Box
1005SK	Pre-Loaded Stent Kit	10 F	5cm	1/Box
1007SK	Pre-Loaded Stent Kit	10 F	7cm	1/Box
1010SK	Pre-Loaded Stent Kit	10 F	10cm	1/Box
1205SK	Pre-Loaded Stent Kit	12 F	5cm	1/Box
1207SK	Pre-Loaded Stent Kit	12 F	7cm	1/Box
1210SK	Pre-Loaded Stent Kit	12 F	10cm	1/Box

* All 7 F Kits Contain Push Catheter Only

Each Pre-Loaded Stent Kit Includes:

- 1 ea. Stent
- 1 ea. Guide Catheter
- 1 ea. Push Catheter

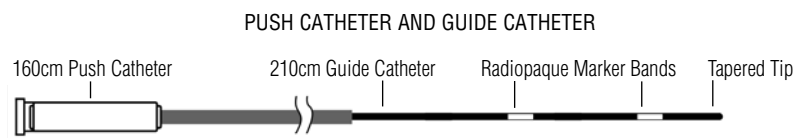

Catalog Number	Description	Push Catheter	Unit
0700G	Stent Introducer Kit * ◊	7 F	1/Box
1006L	Pre-Loaded Stent Introducer Kit ◊	10 F	1/Box
1206L	Pre-Loaded Stent Introducer Kit ◊	12 F	1/Box

* All 7 F Introducer Kits Contain Push Catheter Only

◊ Stent Sold Separately

Each Pre-Loaded Stent Introducer Kit Includes:

- 1 ea. Guide Catheter
- 1 ea. Push Catheter

Plastic Stents

Hydroduct® Biliary Stents

CURVED STENT

Latex **FREE****Sterile, Disposable**

Catalog Number	Description	Stent O.D.	Length	Unit
00705C	Single Stent	7 F	5cm	1/Box
00707C	Single Stent	7 F	7cm	1/Box
00709C	Single Stent	7 F	9cm	1/Box
00712C	Single Stent	7 F	12cm	1/Box
00715C	Single Stent	7 F	15cm	1/Box
01005C	Single Stent	10 F	5cm	1/Box
01007C	Single Stent	10 F	7cm	1/Box
01009C	Single Stent	10 F	9cm	1/Box
01012C	Single Stent	10 F	12cm	1/Box
01015C	Single Stent	10 F	15cm	1/Box
01205C	Single Stent	12 F	5cm	1/Box
01207C	Single Stent	12 F	7cm	1/Box
01209C	Single Stent	12 F	9cm	1/Box
01212C	Single Stent	12 F	12cm	1/Box
01215C	Single Stent	12 F	15cm	1/Box
0705CK	Pre-Loaded Stent Kit *	7 F	5cm	1/Box
0707CK	Pre-Loaded Stent Kit *	7 F	7cm	1/Box
0709CK	Pre-Loaded Stent Kit *	7 F	9cm	1/Box
0712CK	Pre-Loaded Stent Kit *	7 F	12cm	1/Box
0715CK	Pre-Loaded Stent Kit *	7 F	15cm	1/Box
1005CK	Pre-Loaded Stent Kit	10 F	5cm	1/Box
1007CK	Pre-Loaded Stent Kit	10 F	7cm	1/Box
1009CK	Pre-Loaded Stent Kit	10 F	9cm	1/Box
1012CK	Pre-Loaded Stent Kit	10 F	12cm	1/Box
1015CK	Pre-Loaded Stent Kit	10 F	15cm	1/Box
1205CK	Pre-Loaded Stent Kit	12 F	5cm	1/Box
1207CK	Pre-Loaded Stent Kit	12 F	7cm	1/Box
1209CK	Pre-Loaded Stent Kit	12 F	9cm	1/Box
1212CK	Pre-Loaded Stent Kit	12 F	12cm	1/Box
1215CK	Pre-Loaded Stent Kit	12 F	15cm	1/Box

* All 7 F Kits Contain Push Catheter Only

Each Pre-Loaded Stent Kit Includes:

1 ea. Stent

1 ea. Push Catheter

1 ea. Guide Catheter

160cm Push Catheter

PUSH CATHETER AND GUIDE CATHETER

210cm Guide Catheter

Radiopaque Marker Bands

Tapered Tip



Catalog Number	Description	Push Catheter	Unit
0700G	Stent Introducer Kit * ◊	7 F	1/Box
1006L	Pre-Loaded Stent Introducer Kit ◊	10 F	1/Box
1206L	Pre-Loaded Stent Introducer Kit ◊	12 F	1/Box

Each Pre-Loaded Stent Introducer Kit Includes:

1 ea. Guide Catheter

1 ea. Push Catheter

* All 7 F Introducer Kits Contain Push Catheter Only ◊ Stent Sold Separately

■ Plastic Stents



PIGTAIL STENT

Latex **FREE**

Hydroduct® Biliary Stents

Sterile, Disposable

Catalog Number	Description	Stent O.D.	Length	Unit
00704P	Single Stent	7 F	4cm	1/Box
00707P	Single Stent	7 F	7cm	1/Box
00710P	Single Stent	7 F	10cm	1/Box
01004P	Single Stent	10 F	4cm	1/Box
01007P	Single Stent	10 F	7cm	1/Box
01010P	Single Stent	10 F	10cm	1/Box
0704PK	Pre-Loaded Stent Kit *	7 F	4cm	1/Box
0707PK	Pre-Loaded Stent Kit *	7 F	7cm	1/Box
0710PK	Pre-Loaded Stent Kit *	7 F	10cm	1/Box
1004PK	Pre-Loaded Stent Kit	10 F	4cm	1/Box
1007PK	Pre-Loaded Stent Kit	10 F	7cm	1/Box
1010PK	Pre-Loaded Stent Kit	10 F	10cm	1/Box

* All 7 F Kits Contain Push Catheter Only

Each Pre-Loaded Stent Kit Includes:

- 1 ea. Stent
- 1 ea. Guide Catheter
- 1 ea. Push Catheter

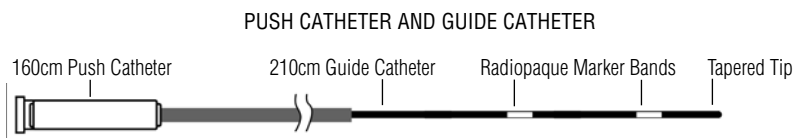

Catalog Number	Description	Push Catheter	Unit
0700G	Stent Introducer Kit * ◊	7 F	1/Box
1006L	Pre-Loaded Stent Introducer Kit ◊	10 F	1/Box
1206L	Pre-Loaded Stent Introducer Kit ◊	12 F	1/Box

* All 7 F Introducer Kits Contain Push Catheter Only

◊ Stent Sold Separately

Each Pre-Loaded Stent Introducer Kit Includes:

- 1 ea. Guide Catheter
- 1 ea. Push Catheter

Metal Stents

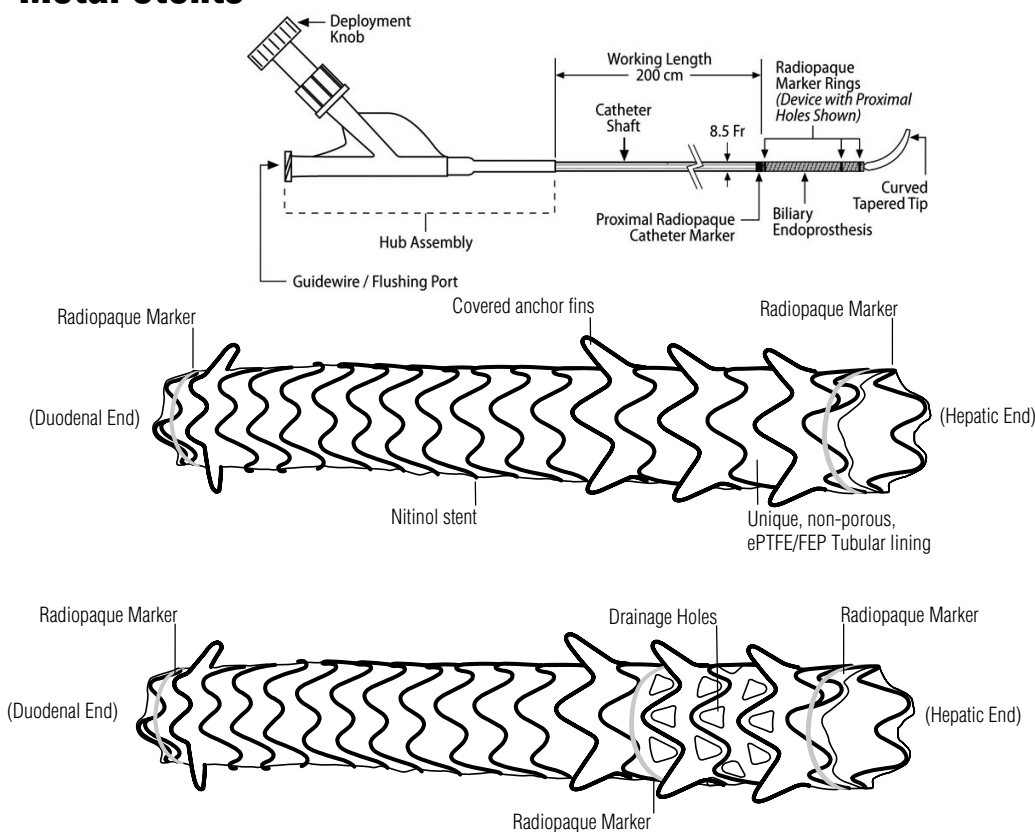

Gore Viabil® Biliary Endoprosthesis

Latex **FREE**

Stent

Catalog Number	Diameter	Length	Catheter Diameter	O.D.	Unit
Holes					
VH0806200	8mm	60mm	200cm	8.5F	1/Box
VH0808200	8mm	80mm	200cm	8.5F	1/Box
VH0810200	8mm	100mm	200cm	8.5F	1/Box
VH1006200	10mm	60mm	200cm	8.5F	1/Box
VH1008200	10mm	80mm	200cm	8.5F	1/Box
VH1010200	10mm	100mm	200cm	8.5F	1/Box
No Holes					
VN0804200	8mm	40mm	200cm	8.5F	1/Box
VN0806200	8mm	60mm	200cm	8.5F	1/Box
VN0808200	8mm	80mm	200cm	8.5F	1/Box
VN0810200	8mm	100mm	200cm	8.5F	1/Box
VN1004200	10mm	40mm	200cm	8.5F	1/Box
VN1006200	10mm	60mm	200cm	8.5F	1/Box
VN1008200	10mm	80mm	200cm	8.5F	1/Box
VN1010200	10mm	100mm	200cm	8.5F	1/Box

Warning: The safety and effectiveness of this device for use in the vascular system have not been established.
MRI Compatible



VIABIL is a registered trademark of W.L. Gore & Associates

■ Metal Stents

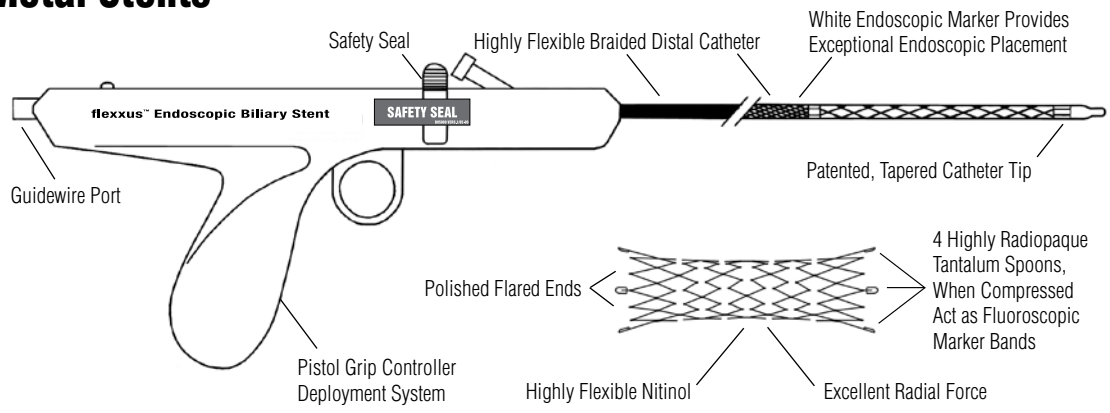

Flexus® Endoscopic Biliary Stent

Latex **FREE**

Sterile, Disposable. Recommended Guidewire: .035" (FXWire™- FX35450S)

Catalog Number	Stent		Catheter		Unit
	Diameter	Length	Diameter	Length	
LXB08040	8mm	40mm	7.5 F	190cm	1/Box
LXB08060	8mm	60mm	7.5 F	190cm	1/Box
LXB08080	8mm	80mm	7.5 F	190cm	1/Box
LXB08100	8mm	100mm	7.5 F	190cm	1/Box
LXB10040	10mm	40mm	7.5 F	190cm	1/Box
LXB10060	10mm	60mm	7.5 F	190cm	1/Box
LXB10080	10mm	80mm	7.5 F	190cm	1/Box
LXB10100	10mm	100mm	7.5 F	190cm	1/Box

ENDOSCOPIC ULTRASOUND



Page 17

Fine Needle Aspiration

Vizeon® Endoscopic Ultrasound Needle 17

■ Fine Needle Aspiration

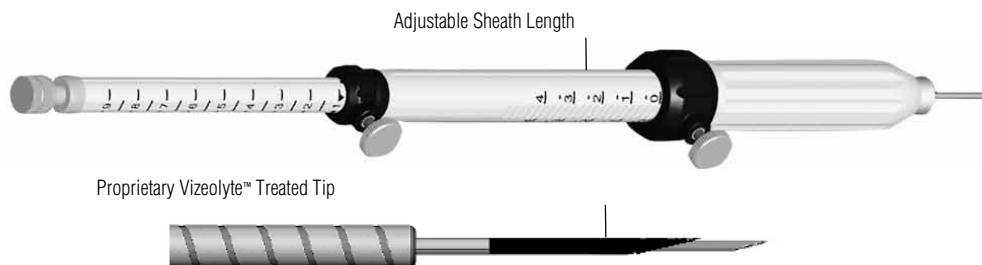

Vizeon® Endoscopic Ultrasound Needle

Latex **FREE**

Sterile, Disposable

Catalog Number	Description	Gauge	Stylet	Needle Diameter	Outer Diameter	Sheath Type	Unit
US1822EB	Vizeon® EUS Needles	22	Extended Bevel	0.7mm/0.028"	1.8mm	Spring Coil	5
US2119R	Vizeon® EUS Needles	19	Round	1.0mm/0.039"	2.1mm	Spring Coil	5
US1822R	Vizeon® EUS Needles	22	Round	0.7mm/0.028"	1.8mm	Spring Coil	5
US2722R	Vizeon® EUS Needles	22	Round	0.7mm/0.028"	2.7mm	Spring Coil	5
US1825R	Vizeon® EUS Needles	25	Round	0.5mm/0.020"	1.8mm	Teflon	5
US2725R	Vizeon® EUS Needles	25	Round	0.5mm/0.020"	2.7mm	Teflon	5

All Vizeon™ Needles include lockable aspiration syringe and valve

DILATION



DILATION

Disposable PET Balloon Dilators

<i>Eliminator® PET Balloon Dilators</i>	19
<i>ConMed® Balloon Inflation Device</i>	19
<i>Multi-Stage Inflation Pressures</i>	19

Reusable Polyvinyl Dilators

<i>American Dilation System</i>	20
---------------------------------	----

Applied Ingenuity™

CONMED™
ENDOSCOPIC TECHNOLOGIES

■ Disposable PET Balloon Dilators

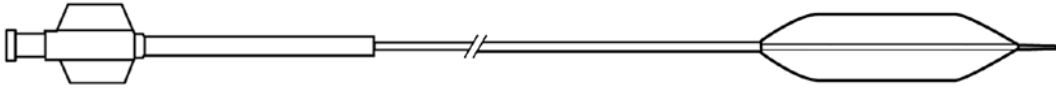

Eliminator® PET Balloon Dilators

Latex **FREE**

Catalog Number	Description	Inflated OD		Balloon Length	Catheter Length	Unit
		mm	French			
000340	Esophageal Balloon Dilator	6mm	18 F	8cm	180cm	1/box
000341	Esophageal Balloon Dilator	8mm	24 F	8cm	180cm	1/box
000342	Esophageal Balloon Dilator	10mm	30 F	8cm	180cm	1/box
000343	Esophageal Balloon Dilator	12mm	36 F	8cm	180cm	1/box
000344	Esophageal Balloon Dilator	15mm	45 F	8cm	180cm	1/box
000345	Esophageal Balloon Dilator	18mm	54 F	8cm	180cm	1/box
000380	Esophageal Balloon Dilator	20mm	60 F	8cm	180cm	1/box
000443	Esophageal Advantage Pack (includes 5 ea. of 12mm)			8cm	180cm	5/box
000735	Esophageal Advantage Pack (includes 5 ea. of 15mm)			8cm	180cm	5/box
000736	Esophageal Advantage Pack (includes 5 ea. of 18mm)			8cm	180cm	5/box
000379	Esophageal Advantage Pack (includes 5 ea. of 20mm)			8cm	180cm	5/box
000844	Pyloric/Colonic Balloon	6mm	18 F	4cm	230cm	1/box
000845	Pyloric/Colonic Balloon	8mm	24 F	4cm	230cm	1/box
000846	Pyloric/Colonic Balloon	10mm	30 F	4cm	230cm	1/box
000847	Pyloric/Colonic Balloon	12mm	36 F	4cm	230cm	1/box
000848	Pyloric/Colonic Balloon	15mm	45 F	4cm	230cm	1/box
000849	Pyloric/Colonic Balloon	18mm	54 F	4cm	230cm	1/box
000861	Pyloric/Colonic Balloon	20mm	60 F	4cm	230cm	1/box
000857	Pyloric/Colonic Advantage Pack (includes 5 ea. of 12mm)			4cm	230cm	5/box
000858	Pyloric/Colonic Advantage Pack (includes 5 ea. of 15mm)			4cm	230cm	5/box
000859	Pyloric/Colonic Advantage Pack (includes 5 ea. of 18mm)			4cm	230cm	5/box
000867	Pyloric/Colonic Advantage Pack (includes 5 ea. of 20mm)			4cm	230cm	5/box

ConMed® Balloon Inflation Device

Latex **FREE**

For Esophageal and Pyloric/Colonic Balloon Dilators

Catalog Number	Description	Unit
100851	ConMed® Balloon Inflation Device	1/box

Multi-Stage Inflation Pressures

For Esophageal and Pyloric/Colonic Balloon Dilators

Balloon Size	Stage One	Stage Two	Stage Three*
6mm/18 F	60 psi/4.1 atm	90 psi/6.1 atm	120 psi/8.2 atm
8mm/24 F	60 psi/4.1 atm	90 psi/6.1 atm	120 psi/8.2 atm
10mm/30 F	45 psi/3.1 atm	68 psi/4.0 atm	90 psi/6.1 atm
12mm/36 F	45 psi/3.1 atm	68 psi/4.0 atm	90 psi/6.1 atm
15mm/45 F	30 psi/2.0 atm	45 psi/3.1 atm	60 psi/4.1 atm
18mm/54 F	25 psi/1.7 atm	38 psi/2.6 atm	50 psi/3.4 atm
20mm/60 F	25 psi/1.7 atm	38 psi/2.6 atm	50 psi/3.4 atm

*Maximum recommended inflation pressure

Reusable Polyvinyl Dilators

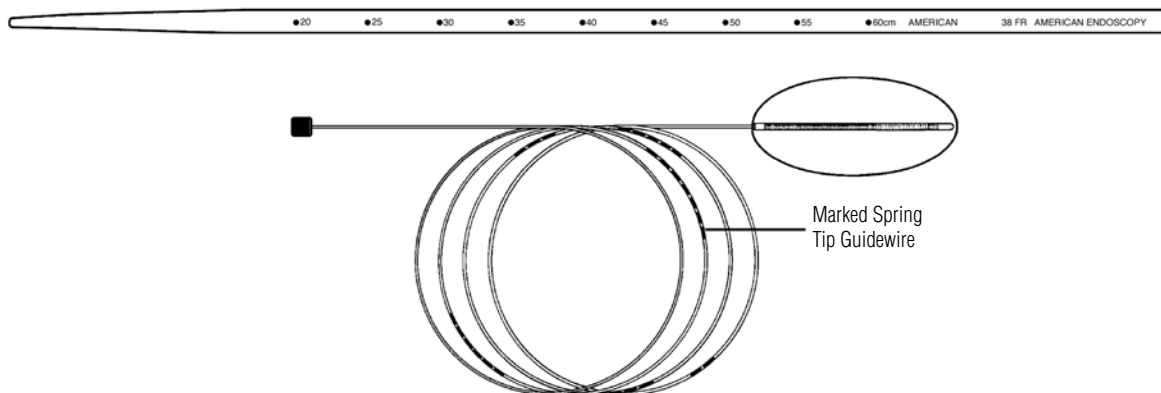

American Dilation System

Non-Sterile, Reusable

Catalog Number	Description	Size	Unit
000250*	American Dilatation System		1/box
000270	Tapered Over-The-Wire Dilator	15 F	1/box
000288	Tapered Over-The-Wire Dilator	18 F	1/box
000271	Tapered Over-The-Wire Dilator	21 F	1/box
000289	Tapered Over-The-Wire Dilator	24 F	1/box
000272	Tapered Over-The-Wire Dilator	27 F	1/box
000273	Tapered Over-The-Wire Dilator	30 F	1/box
000274	Tapered Over-The-Wire Dilator	33 F	1/box
000275	Tapered Over-The-Wire Dilator	36 F	1/box
000290	Tapered Over-The-Wire Dilator	39 F	1/box
000277	Tapered Over-The-Wire Dilator	42 F	1/box
000278	Tapered Over-The-Wire Dilator	45 F	1/box
000279	Tapered Over-The-Wire Dilator	48 F	1/box
000280	Tapered Over-The-Wire Dilator	51 F	1/box
000281	Tapered Over-The-Wire Dilator	54 F	1/box
000291	Tapered Over-The-Wire Dilator	60 F	1/box

Accessories for American Dilators

000150	Marked Spring Tip Guidewire	2/box
000249	American Dilator Carrying Case	1/box
000336	American Dilator Cleaning Brush	3/box
000337	Cleaning Adaptor	2/box

*** Each American Dilation System Includes:**

- | | |
|---------------------------------------|----------------------|
| 15 ea. Tapered over-the-wire dilators | 1 ea. Cleaning brush |
| 1 ea. Marked spring tip guidewire | 1 ea. Carrying case |
| 2 ea. Cleaning adaptor | |

HEMOSTASIS

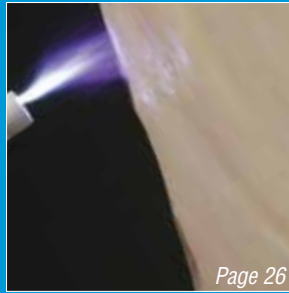

Page 26

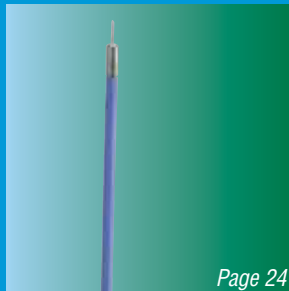
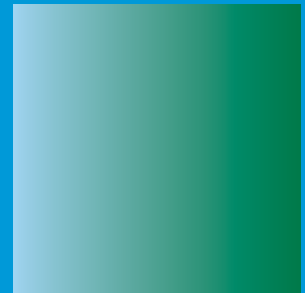
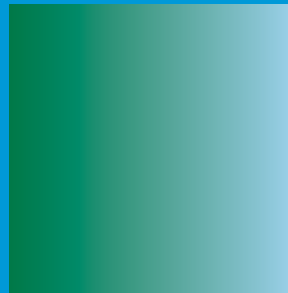

Page 24

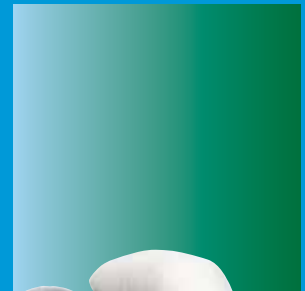

Ligation Devices

- Auto-Band Ligator 21
- Stiegmann-Goff™ Endoscopic Ligator Kit 22
- ConMed® Endoscopic Overtube 22
- Stiegmann-Goff™ Bandito™ Endoscopic Ligator 23

Disposable Injection Needles

- Sure Shot® Metal Sheathed Injection Needle 24
- Click-Tip™ Injection Needle 24
- Flexitip™ Disposable Sclerotherapy Needles 24

Hemostasis Probes

- BiCap Superconductor™ Multi-electrode Bipolar Probes 25
- Beamer™ Argon Snare Probe 25
- Beamer™ Argon Probe 25

Bipolar Probes

- Coaxial Bipolar Adaptors 26
- * For use with Everest™ and ValleyLab™ Generators 26

Bipolar/Monopolar Generator

- Beamer™ System CE600 27
- Beamer™ Irrigation Pump 27
- Accessories for Beamer™ Irrigation Pump 27

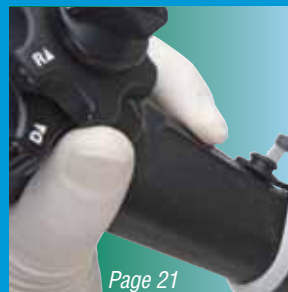

Page 21

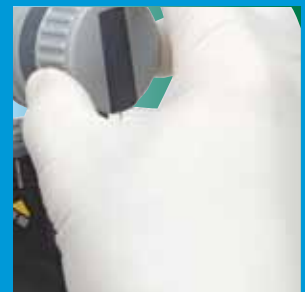

■ Ligation Devices

Auto-Band Ligator

Sterile, Disposable

Variceal Ligator	Scope Model & Tip Size	Outer Diameter Scope Range (mm)	Quantity of Bands	Latex-Free	Attachment Type	Unit
Gastrosopes						
SABLU6L	Olympus	8.6 – 11.0	6	No	Snap Fit	1/Box
SABLU6VL	Pentax	8.6 – 11.0	6	No	Velcro	1/Box
SABLU7	Olympus	8.6 – 11.0	7	Yes	Snap Fit	1/Box
SABLU7V	Pentax	8.6 – 11.0	7	Yes	Velcro	1/Box
SABLU8L	Olympus	8.6 – 11.0	8	No	Snap Fit	1/Box
SABLU8VL	Pentax	8.6 – 11.0	8	No	Velcro	1/Box
SABLU10	Olympus	8.6 – 11.0	10	Yes	Snap Fit	1/Box
SABLU10V	Pentax	8.6 – 11.0	10	Yes	Velcro	1/Box
SABLA6CGL	Olympus	11.0 – 14.0	6	No	Snap Fit	1/Box
SABLA6VCGL	Pentax	11.0 – 14.0	6	No	Velcro	1/Box
Colonoscopes						
SABLA5CL	Olympus	11.0 – 14.0	5	No	Snap Fit	1/Box
SABLA5VCL	Pentax	11.0 – 14.0	5	No	Velcro	1/Box
SABLA5C	Olympus	11.0 – 14.0	5	Yes	Snap Fit	1/Box
SABLA5VC	Pentax	11.0 – 14.0	5	Yes	Velcro	1/Box

Ligation Devices

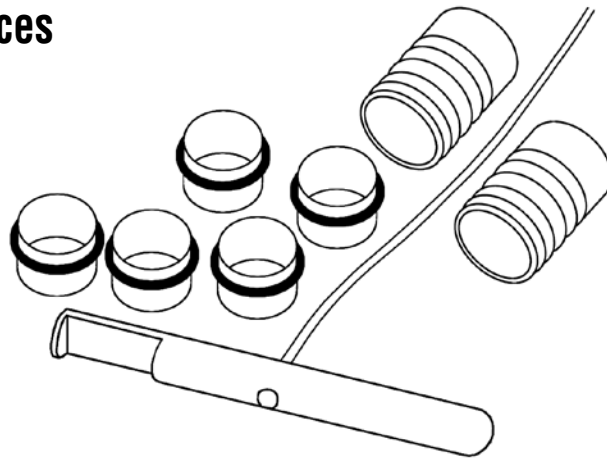

Stiegmann-Goff™ Endoscopic Ligator Kit

Non-Sterile, Disposable

Catalog Number	Description	Inner Cylinders	Maximum Scope Length	Scope Tip Diameter	Minimum Working Channel O.D.	Unit
200220	Endoscopic Ligator	5	130cm	9 -11mm	2.8mm	5 kits/box
200221	Endoscopic Ligator	10	130cm	9 -11mm	2.8mm	5 kits/box
000221	Clearvue™ Endoscopic Ligator	5	130cm	9 -11mm	2.8mm	5 kits/box
000227	Clearvue™ Endoscopic Ligator	10	130cm	9 -11mm	2.8mm	5 kits/box

Each Stiegmann-Goff™ Endoscopic Ligator Includes:

- 1 ea. Monofilament trip wire
- 1 ea. Friction fit adaptors for 9-11mm and 11-13mm scopes
- 5 ea. (200220/000221) inner cylinders with preloaded bands or
- 10 ea. (200221/000227) inner cylinders with preloaded bands

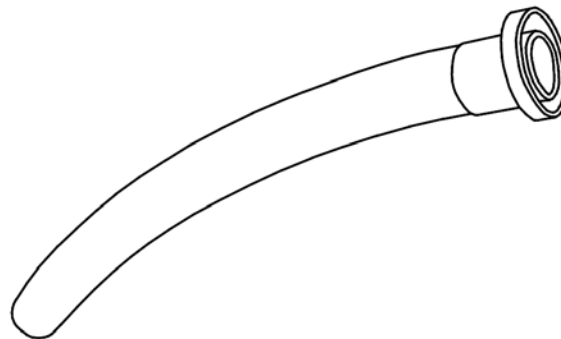

ConMed® Endoscopic Overtube

Latex **FREE**

Non-Sterile, Reusable

Catalog Number	Description	O.D.	I.D.	Length	Reuses	Unit
000230*	ConMed® Endoscopic Overtube	60 F	45 F	23cm	25	1/box

* For use with the Scope Saver™ Disposable Bite Block, no. 000429

■ Ligation Devices

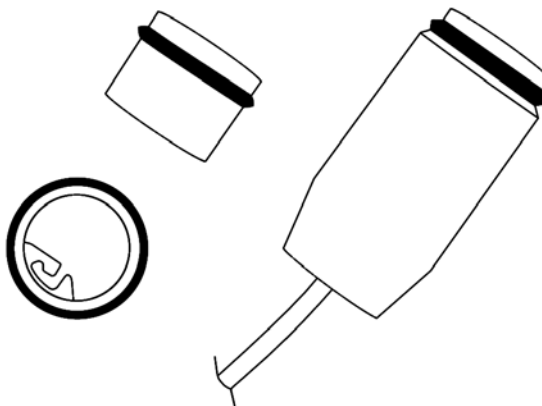

Stiegmann-Goff™ Bandito™ Endoscopic Ligator

Non-Sterile, Disposable

Catalog Number	Description	Endoscope Compatibility	Maximum Scope Length	Scope Tip Diameter	Minimum Working Channel	Unit
100225	Endoscopic Hemorrhoid Ligator	Colonoscope	210cm	13 -15mm	2.8mm	5 kits/box
100226	Endoscopic Hemorrhoid Ligator	Flexible Sigmoidoscope	80cm	13 -15mm	2.8mm	5 kits/box

1 ea. Monofilament trip wire

1 ea. Friction fit adaptor for 13-15mm scopes

3 ea. Clear inner cylinder with preloaded bands

■ Disposable Injection Needles

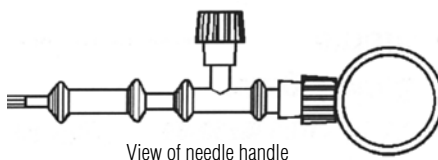

Sure Shot® Metal Sheathed Injection Needle

Latex **FREE**

Sterile, Disposable

Catalog Number	Description	Needle		Sheath		Unit
		Length	Gauge	Length	O.D.	
100218	Metal Sheathed Injection Needle	5mm	25 g	230cm	2.5mm	5/box



Click-Tip™ Injection Needle

Latex **FREE**

Sterile, Disposable

Catalog Number	Needle Diameter	Needle Length	Catheter OD	Catheter Length	Unit
02-23-180	19 Gauge Injection Needle	4 mm	2.3 mm	180 cm	10
02-23-230	19 Gauge Injection Needle	4 mm	2.3 mm	230 cm	10
04-23-180	19 Gauge Injection Needle	6 mm	2.3 mm	180 cm	10
04-23-230	19 Gauge Injection Needle	6 mm	2.3 mm	230 cm	10
01-19-180	22 Gauge Injection Needle	4 mm	1.9 mm	180 cm	10
01-19-230	22 Gauge Injection Needle	4 mm	1.9 mm	230 cm	10
03-19-180	22 Gauge Injection Needle	6 mm	1.9 mm	180 cm	10
03-19-230	22 Gauge Injection Needle	6 mm	1.9 mm	230 cm	10
05-19-180	25 Gauge Injection Needle	4 mm	1.9 mm	180 cm	10
05-19-230	25 Gauge Injection Needle	4 mm	1.9 mm	230 cm	10
06-19-180	25 Gauge Injection Needle	6 mm	1.9 mm	180 cm	10
06-19-230	25 Gauge Injection Needle	6 mm	1.9 mm	230 cm	10



Flexitip™ Disposable Sclerotherapy Needles

Latex **FREE**

Sterile, Disposable

Catalog Number	Description	Needle		Sheath		Unit
		Length	Gauge	Length	O.D.	
000215	Optic Yellow Tip Needle	4mm	25 g	160cm	2.3mm	5/box
000216	Optic Yellow Tip Needle	5mm	25 g	160cm	2.3mm	5/box
000217	Optic Yellow Tip Needle	6mm	25 g	160cm	2.3mm	5/box
000218	Optic Yellow Tip Colonoscope Needle	5mm	25 g	230cm	2.3mm	5/box
000198	Standard Needle	4mm	25 g	160cm	2.3mm	5/box
000199	Standard Needle	5mm	25 g	160cm	2.3mm	5/box
000200	Standard Needle	6mm	25 g	160cm	2.3mm	5/box
000138	Standard Colonoscope Needle	5mm	25 g	230cm	2.3mm	5/box

■ Hemostasis Probes

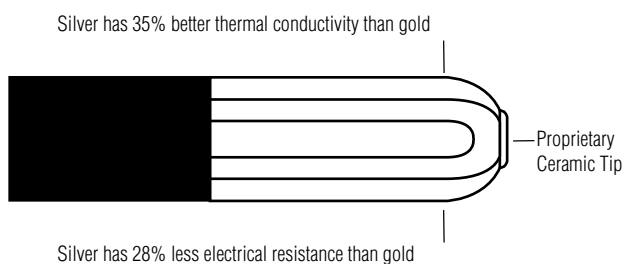

Three pairs of Positive and Negative Parallel Silver Electrodes

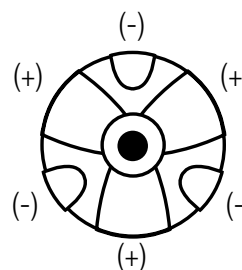

BiCap Superconductor™ Multi-electrode Bipolar Probes

Latex **FREE**

Sterile, Disposable

Catalog Number	Description	Shaft Size	Shaft Length	Tip Length	Color	Unit
BP-5200A	Bipolar, 6 Silver Electrode, Hemostasis Probe	5 Fr	200cm	6.5mm	Blue	1/Box
BP-7300A	Bipolar, 6 Silver Electrode, Hemostasis Probe	7 Fr	300cm	6.5mm	Yellow	1/Box
BP-7350A	Bipolar, 6 Silver Electrode, Hemostasis Probe	7 Fr	350cm	6.5mm	Yellow	1/Box
BP-7350S	Bipolar, 6 Silver Electrode, Hemostasis Probe	7 Fr	350cm	3.3mm	Yellow	1/Box
BP-10300A	Bipolar, 6 Silver Electrode, Hemostasis Probe	10 Fr	300cm	6.5mm	Orange	1/Box

Beamer™ Argon Snare Probe

Latex **FREE**

Sterile, Disposable

Catalog Number	Description	Unit
Beamsnare-1	Beamer Snare Probe 2.5MM X 160 (15MM, Firm Spiral Braided Oval Loop) (Bronchoscope)	5/case
Beamsnare-2	Beamer Snare Probe 2.5MM X 230 (15MM, Firm Spiral Braided Oval Loop) (Gastroscope/Colonoscope/Duodenoscope)	5/case
Beamsnare-3	Beamer Snare Probe 2.5MM X 230 (30MM, Firm Spiral Braided Oval Loop) (Gastroscope/Colonoscope/Duodenoscope)	5/case
Beamsnare-4	Beamer Snare Probe 2.5MM X 230 (15MM, Oval, Monofilament Firm Loop) (Gastroscope/Colonoscope/Duodenoscope)	5/case
Beamsnare-5	Beamer Snare Probe 2.5MM X 230 (30MM, Oval, Monofilament Firm Loop) (Gastroscope/Colonoscope/Duodenoscope)	5/case

Beamer™ Argon Probe

Latex **FREE**

Sterile, Disposable

Catalog Number	Description	Unit
A-Beam-1	Beamer Probe 1.8MM X 160CM (Bronchoscope)	10/case
A-Beam-2	Beamer Probe 1.8MM X 320CM (Enteroscope)	10/case
A-Beam-3	Beamer Probe 2.3MM X 230CM (Gastroscope/Colonoscope/Duodenoscope)	10/case
A-Beam-4	Beamer Probe 2.3MM X 320CM (Enteroscope)	10/case
A-Beam-5	Beamer Probe 3.2MM X 230CM (Gastroscope/Colonoscope/Duodenoscope)	10/case

■ Bipolar Probes

Coaxial Bipolar Adaptors

Latex **FREE**

Non-Sterile, Reusable

Catalog Number	Description	Unit
133001	Coaxial Bipolar Adapter (For use with the System 7500® & System 7550®)	1/Box
133002	Coaxial Bipolar Adapter * (For use with the System 5000™ & System 2450®)	1/Box

*For use with Everest™ and ValleyLab™ Generators

■ Bipolar/Monopolar Generator



Beamer™ System CE600

Latex **FREE**

Catalog Number	Description
CE200	Beamer™ Mate Electrosurgical Generator
CB200	Beamer™ Plus Argon Gas Module
CC200	Beamer™ Cart
CE200-A01	Double Foot Pedal with Foot Lift Bar
CB200-A01	Beamer™ Connection Cable for Argon Probes

Beamer™ Irrigation Pump

Latex **FREE**

Catalog Number	Description	Unit
CETEGP-100	Irrigation Pump for Endoscopy Fits on Beamer™ Cart with Beamer System CE600 or as a Stand Alone Irrigation System	1/Box

Each CETEGP-100 includes:

- 1 ea Foot Switch
- 1 ea Power Cord
- 1 ea Bottle Holder
- 1 ea Pump Head

Accessories for Beamer™ Irrigation Pump

Latex **FREE**

Catalog Number	Description	Unit
CET230	Beamer Pump Tubing Set	10/Box
CETEGP-014	Replacement Pump Head	1/Box
CETEGP-009	Replacement Foot Switch	1/Box
CETEGP-012	Replacement Power Cord	1/Box
CET270	Replacement Bottle Holder	1/Box

BIOPSY

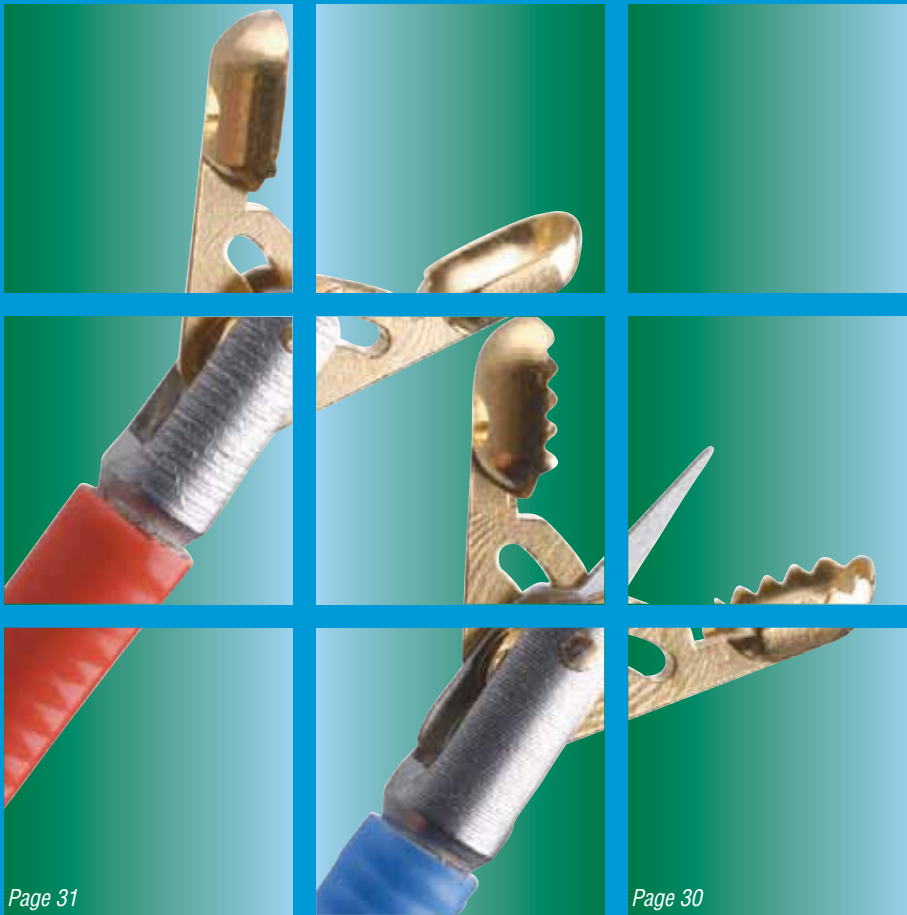

BIOPSY

Disposable Biopsy Forceps	29
Optibite™ Disposable Biopsy Forceps	29
Precisor® EXL™ Coated Disposable Biopsy Forceps	29
Pediatric GI Precisor® Disposable Biopsy Forceps	30
Precisor® Hot Disposable Biopsy Forceps	31
Precisor Broncho® Disposable Biopsy Forceps	31
Disposable Percutaneous Biopsy Instrument	
Monopty® Percutaneous Biopsy Instrument Kits	32
Disposable GI Cytology Brushes	
ConMed® Cytology Brushes	33
Cytology Brushes	33

■ Disposable Biopsy Forceps

Optibite™ Disposable Biopsy Forceps

Sterile, UnCoated

Catalog Number	Jaw Configuration	Jaw Size	Shaft Length	Unit/Box
100571	Alligator cup w/needle	2.3mm	230cm	10/Bx
100572	Alligator cup w/o needle	2.3mm	230cm	10/Bx
100573	Oval cup w/needle	2.3mm	230cm	10/Bx
100574	Oval cup w/o needle	2.3mm	230cm	10/Bx

Sterile, Coated

100575	Alligator cup w/needle	2.3mm	230cm	10/Bx
100576	Alligator cup w/o needle	2.3mm	230cm	10/Bx
100577	Oval cup w/needle	2.3mm	230cm	10/Bx
100578	Oval cup w/o needle	2.3mm	230cm	10/Bx

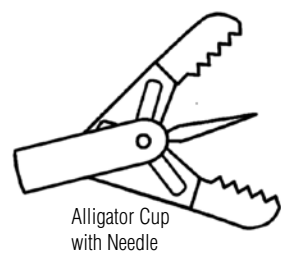
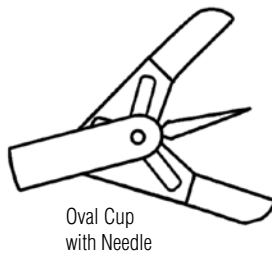
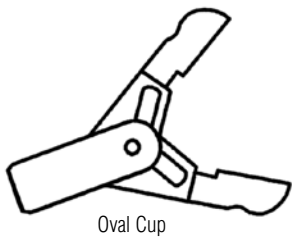

Precisor® EXL™ Coated Disposable Biopsy Forceps

Latex **FREE**

Featuring Channel-Guard™ Low Friction Sheath

Sterile, Coated

Catalog Number	Jaw Configuration	Jaw		Shaft	
		O.D.	Length	Color	Unit
Standard GI					
000381	Alligator Cup	2.3mm	160cm	Yellow	10/box
000382	Alligator Cup with Needle	2.3mm	160cm	Yellow	10/box
000383	Oval Cup	2.3mm	160cm	Yellow	10/box
000384	Oval Cup with Needle	2.3mm	160cm	Yellow	10/box
000385	Alligator Cup	2.3mm	230cm	Blue	10/box
000386	Alligator Cup with Needle	2.3mm	230cm	Blue	10/box
000389	Oval Cup	2.3mm	230cm	Blue	10/box
000388	Oval Cup with Needle	2.3mm	230cm	Blue	10/box
Jumbo GI					
00820C	Oval Cup	3.1mm	230cm	Blue	10/box
00821C	Oval Cup with Needle	3.1mm	230cm	Blue	10/box
00822C	Alligator Cup	3.1mm	230cm	Blue	10/box
00823C	Alligator Cup with Needle	3.1mm	230cm	Blue	10/box

Disposable Biopsy Forceps

Pediatric GI

Latex **FREE**

<i>Sterile, Coated</i>		Jaw	Shaft		
Catalog Number	Jaw Configuration	O.D.	Length	Color	Unit
100512	Oval Cup	1.8mm	160cm	Yellow	10/box
100513	Alligator Cup	1.8mm	160cm	Yellow	10/box

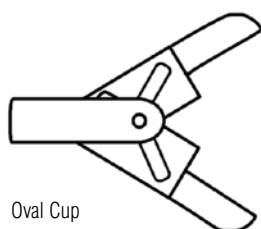

Oval Cup

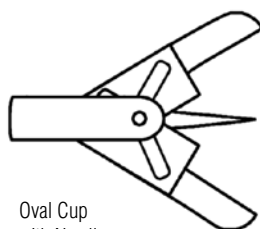

Oval Cup with Needle

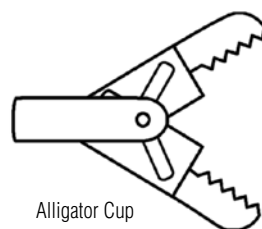

Alligator Cup

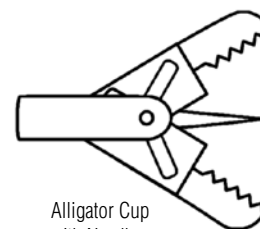

Alligator Cup with Needle

Precisor® Disposable Biopsy Forceps

Latex **FREE**

<i>Sterile, Uncoated</i>				
Catalog Number	Jaw Configuration	Jaw O.D.	Shaft Length	Unit
Standard GI				
000837	Oval Cup	2.3mm	160cm	10/box
000838	Oval Cup with Needle	2.3mm	160cm	10/box
000840	Alligator Cup	2.3mm	160cm	10/box
000841	Alligator Cup with Needle	2.3mm	160cm	10/box
000816	Oval Cup	2.3mm	230cm	10/box
000817	Oval Cup with Needle	2.3mm	230cm	10/box
000818	Alligator Cup	2.3mm	230cm	10/box
000819	Alligator Cup with Needle	2.3mm	230cm	10/box
Jumbo GI				
000820	Oval Cup	3.1mm	230cm	10/box
000821	Oval Cup with Needle	3.1mm	230cm	10/box
000822	Alligator Cup	3.1mm	230cm	10/box
000823	Alligator Cup with Needle	3.1mm	230cm	10/box
Pediatric GI				
100516	Oval Cup	1.8mm	160cm	10/box
100517	Alligator Cup	1.8mm	160cm	10/box

■ Disposable Biopsy Forceps

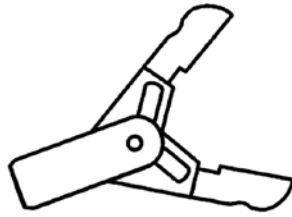

Oval Cup

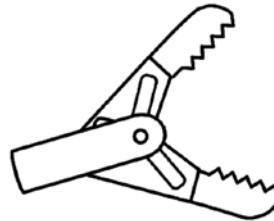

Alligator Cup

Precisor® Hot Disposable Biopsy Forceps

Latex **FREE**

Sterile, Coated

Catalog Number	Configuration	Jaw	Shaft				Unit
		O.D.	Length	Coating	Cord		
000852	Oval Cup	2.3mm	230cm	Red	Olympus®	10/box	
000853	Oval Cup	2.3mm	230cm	Red	Microvasive®	10/box	
000854	Alligator Cup	2.3mm	230cm	Red	Olympus	10/box	
000856	Alligator Cup	2.3mm	230cm	Red	Microvasive	10/box	

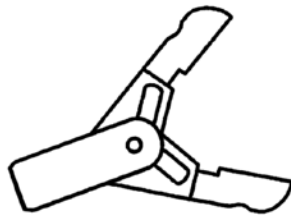

Oval Cup



Alligator Cup

Precisor Broncho® Disposable Biopsy Forceps

Latex **FREE**

Sterile, Disposable

Catalog Number	Description	Shaft Length	Jaw O.D.	Unit
100502	Oval Cup Forceps/Channel-Guard™ Coated Shaft	115cm	1.8mm	10/box
100503	Alligator Cup Forceps/Channel-Guard™ Coated Shaft	115cm	1.8mm	10/box
100506	Oval Cup Forceps	115cm	1.8mm	10/box
100507	Alligator Cup Forceps	115cm	1.8mm	10/box

■ Disposable Percutaneous Biopsy Instrument

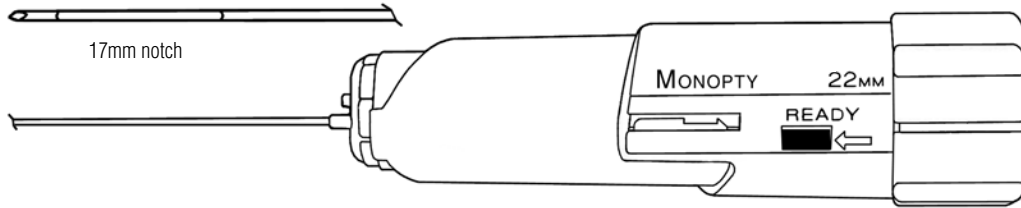

Monopty® Percutaneous Biopsy Instrument Kits

Latex **FREE**

Sterile, Disposable

Catalog Number	Description	Size	Penetration	Notch	Length	Unit
000402 *	Monopty Biopsy Instrument Kit	18 g/1.2mm	22mm	17mm	20cm	5/box
000439 *	Monopty Biopsy Instrument Kt	16 g/1.7mm	22mm	17mm	16cm	5/box
000441*	Monopty Biopsy Instrument Kit	14 g/2.1mm	22mm	17mm	16cm	5/box

* The syringe plunger in all kits contains latex.

Each Monopty Biopsy Instrument Kit Includes:

- | | |
|--|---|
| 1 ea. Monopty biopsy instrument includes cm gradations | 1 ea. 5 cc syringe |
| 1 ea. 25 ml sample vial | 1 ea. 25 gauge x 5/8" needle |
| 1 ea. Patient label | 1 ea. 21 gauge x 1 1/2" needle |
| 1 ea. Thumb forceps | 1 ea. Triple pack povidone-iodine swabs |
| 2 ea. 5.5 cm diameter filter paper | 3 ea. 3" x 3" gauze pads |
| 1 ea. Adhesive bandage | 1 ea. CSR wrap |
| 1 ea. 24" x 36" fenestrated drape | |
| 1 ea. Scalpel with No. 11 surgical blade | |

■ Disposable GI Cytology Brushes

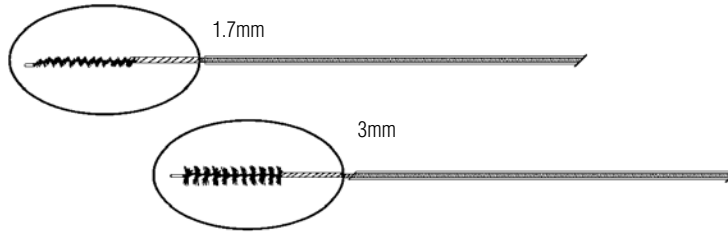

ConMed® Cytology Brushes

Latex **FREE**

Sterile, Disposable

Catalog Number	Description	Scope	Brush Diameter	Sheath O.D.	Length	Unit
000104	Sheathed	Multi-Purpose	1.7mm	1.7mm	160cm	20/box
000108	Sheathed	Pediatric Gastroscope	3.0mm	1.7mm	160cm	20/box
000109	Sheathed	Duodenoscope	3.0mm	1.8mm	200cm	20/box
000110	Sheathed	Colonoscope	3.0mm	2.1mm	230cm	20/box
000196	Sheathed	Adult Gastroscope	3.0mm	2.0mm	160cm	20/box

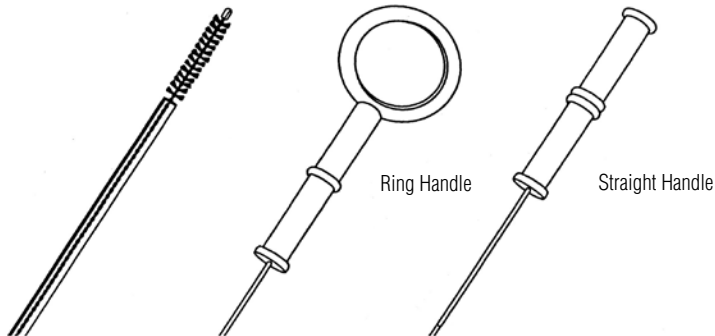

Cytology Brushes

Latex **FREE**

Sterile, Disposable

Catalog Number	Description	Brush	Sheath		Unit
		Diameter	Length	Diameter	
151	Straight Handle	2.5mm	160cm	1.7mm	20/box
151R	Ring Handle	2.5mm	160cm	1.7mm	20/box
152	Straight Handle	2.5mm	200cm	1.8mm	20/box
152R	Ring Handle	2.5mm	200cm	1.8mm	20/box
163	Straight Handle	3.0mm	160cm	2.4mm	20/box
163R	Ring Handle	3.0mm	160cm	2.4mm	20/box
158	Straight Handle	3.0mm	230cm	2.4mm	20/box
158R	Ring Handle	3.0mm	230cm	2.4mm	20/box

GASTROSTOMY

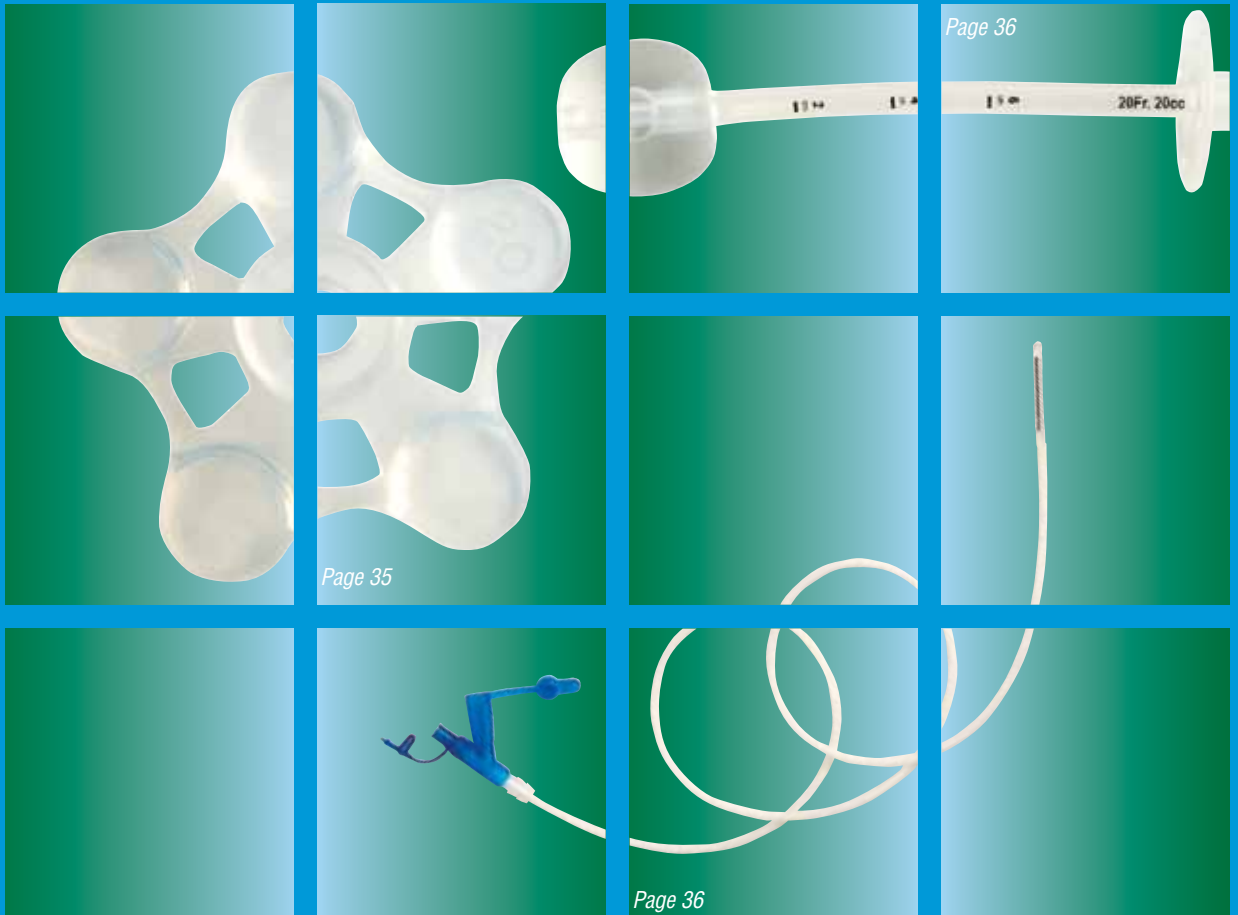

Gastrostomy Feeding Systems

EnTake™ PEG System 35

Replacement Gastrostomy

Tube (G-Tube)

EnTake™ Tri-Funnel Replacement G-Tube 36

Jejunal Feeding Tubes

EnTake™ J-Tube Feeding Tubes 36

Applied Ingenuity™

CONMED™
ENDOSCOPIC TECHNOLOGIES

■ Gastrostomy Feeding Systems



EnTake™ PEG System

Sterile, Disposable

Catalog Number	Description	Technique	French Size	Unit
FESG1400	Safety	Push	14	1/box
FESG1800	Safety	Push	18	1/box
FESG2000	Safety	Push	20	1/box
FESG2400	Safety	Push	24	1/box
FESP1400	Safety	Pull	14	1/box
FESP1800	Safety	Pull	18	1/box
FESP2000	Safety	Pull	20	1/box
FESP2400	Safety	Pull	24	1/box
FEXG1400	Standard	Push	14	1/box
FEXG1800	Standard	Push	18	1/box
FEXG2000	Standard	Push	20	1/box
FEXG2400	Standard	Push	24	1/box
FEXP1400	Standard	Pull	14	1/box
FEXP1800	Standard	Pull	18	1/box
FEXP2000	Standard	Pull	20	1/box
FEXP2400	Standard	Pull	24	1/box
Accessories				
FEDP1400	Dual Port Feeding Adapter	-	14 F	5/box
FEDP1820	Dual Port Feeding Adapter	-	18 F and 20 F	5/box
FEDP2400	Dual Port Feeding Adapter	-	24 F	5/box
FEAC1400	Small White Tubing Clamp	-	14 F	10/box
FEAC2000	Large White Tubing Clamp	-	18 F, 20 F and 24 F	10/box

EnTake™ PEG System includes:

Patient Prep and Access

- 1 ea Fenestrated drape, 24" x 26"
- 1 ea Surgical Skin Marker
- 1 ea Triple pack Chloraprep® Swabsticks
- 1 ea Lidocaine, HCl 1% 10cc plastic ampule
- 1 ea 5cc syringe*
- 1 ea Injection Needle
- 1 ea Scalpel*
- 1 ea Introducer Needle*
- 1 ea Snare, disposable grasping

*Safety features available within Safety PEG System

PEG Placement

- 1 ea Blue cable hoop (Pull Only)
- 1 ea Guidewire (Push Only)
- 1 ea PEG Tube (Traction Removal)
- 10 ea Gauze Pads, 4" x 4"
- 1 ea Lubricating jelly
- 1 ea Scissors, blunt end disposable
- 1 ea Hemostat, disposable curved metal
- 1 ea Linear bolster
- 1 ea Star bolster
- 1 ea Tubing Clamp
- 1 ea Two Port Feeding adapter
- 4 ea Gauze pads, 2" x 2" fenestrated
- 1 ea Ointment, Iodophor PVP

■ Replacement Gastrostomy Tube (G-Tube)



EnTake™ Tri-Funnel Replacement G-Tube

Sterile, Disposable

Catalog Number	Description	Rated Inflation Volume	Tube Size	Unit
RMGB1400	Ballloon Replacement	5cc	14F / 4.7mm	5/Box
RMGB1800	Ballloon Replacement	20cc	18F / 6.0mm	5/Box
RMGB2000	Ballloon Replacement	20cc	20F / 6.7mm	5/Box
RMGB2400	Ballloon Replacement	20cc	24F / 8.0mm	5/Box

EnTake™ Tri-Funnel Replacement G-Tube System includes:

- Tri-Funnel Replacement G-Tube
- Lubricating Jelly
- Inflation syringe

■ Jejunal Feeding Tubes

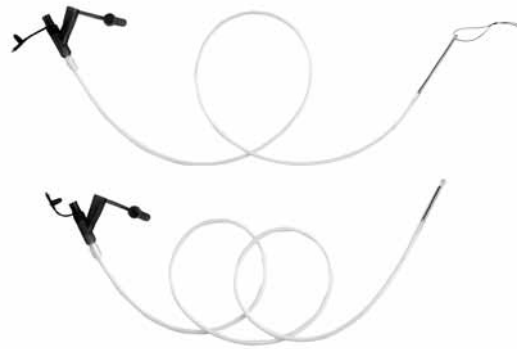

EnTake™ J-Tube Feeding Tubes

Sterile, Disposable

Catalog Number	Technique	Diameter	Chatheter Length	Unit
RBJP0900	Pull	9F	35 in.	2/Box
RBJG0900	Push (GW)	9F	35 in.	2/Box
RBJP1200	Pull	12F	35 in.	2/Box
RBJG1200	Push (GW)	12F	35 in.	2/Box

EnTake™ J-Tube System includes:

- 35" Weighted polyurethane jejunal feeding tube
- Syringe containing 10cc sterile water
- 260cm PTFE coated guidewire (push method only)
- Stylet (pull method only)

POLYPECTOMY

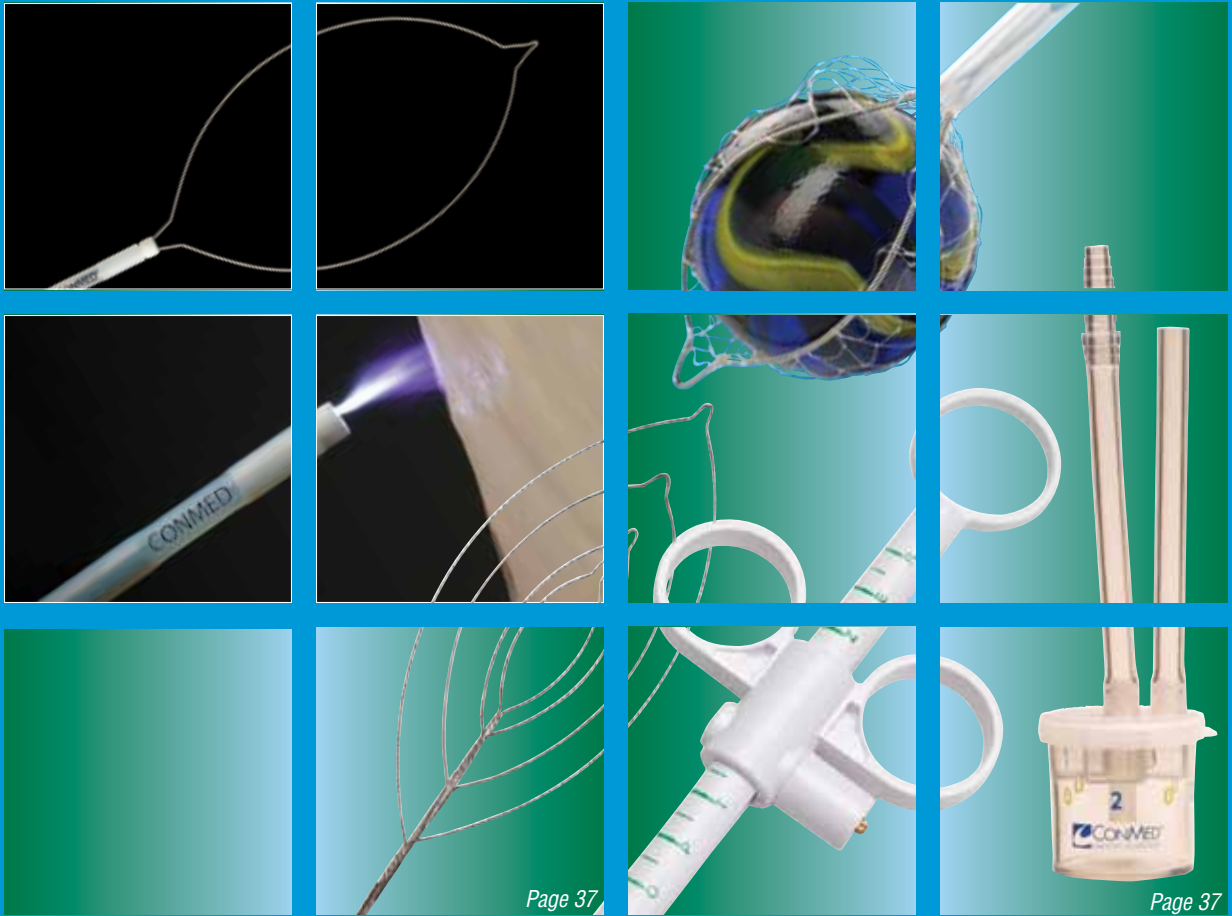

POLYPECTOMY

Specimen Devices

<i>Nakao Spider-Net™ Retrieval Devices</i>	37
<i>Beamer Argon Snare Probe</i>	37
<i>Beamer Argon Probe</i>	37
<i>Optimizer® Multi-Chamber Polyp Trap</i>	37

Disposable Snares

<i>Orbit-Snare™ Rotatable</i>	
<i>Polypectomy Snares</i>	38
<i>Optimizer® Polypectomy Snares</i>	38
<i>Active Cord</i>	38
<i>Singular™ Polypectomy Snares</i>	39
<i>Disposable Snare Assembly To Fit Olympus® Handle</i>	40
<i>Disposable Snare Assembly To Fit Cameron-Miller™ Handle</i>	40
<i>Disposable Snare Assembly ConMed® Handle</i>	40

■ Specimen Devices

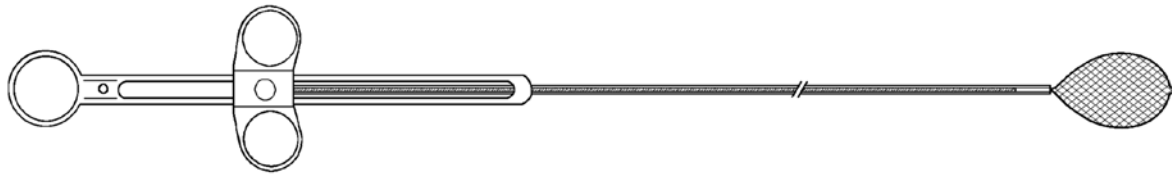

Nakao Spider-Net™ Retrieval Devices

Latex **FREE**

Non-Sterile, Disposable

Catalog Number	Description	Approximate		Length	Unit
		Net Size	Net Volume		
0230AM	Standard Nakao Spider-Net™ Multi-Pack	3 x 6cm	7cc	230cm	20/Box
00230A	Standard Nakao Spider-Net™	3 x 6cm	7cc	230cm	10/Box
0160MG	Standard Nakao Spider-Net™ - EGD	3 x 6cm	7cc	160cm	5/Box

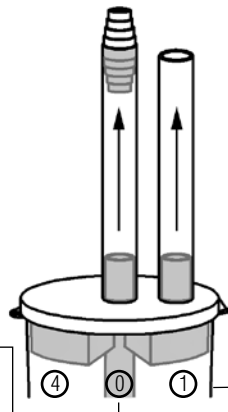

Optimizer® Multi-Chamber Polyp Trap

Latex **FREE**

Non-Sterile, Disposable

Catalog Number	Description	Chambers	Unit
CAP132	Multi Chamber Polyp Trap	4	20/box

Four bypass chambers
Four collection chambers

Beamer Argon Snare Probe

Latex **FREE**

Sterile, Disposable

Catalog Number	Description	Unit
Beamsnare-1	Beamer Snare Probe 2.5MM X 160 (15MM, Firm Spiral Braided Oval Loop) (Bronchoscope)	5/case
Beamsnare-2	Beamer Snare Probe 2.5MM X 230 (15MM, Firm Spiral Braided Oval Loop) (Gastroscope/Colonoscope/Duodenoscopy)	5/case
Beamsnare-3	Beamer Snare Probe 2.5MM X 230 (30MM, Firm Spiral Braided Oval Loop) (Gastroscope/Colonoscope/Duodenoscopy)	5/case
Beamsnare-4	Beamer Snare Probe 2.5MM X 230 (15MM, Oval, Monofilament Firm Loop) (Gastroscope/Colonoscope/Duodenoscopy)	5/case
Beamsnare-5	Beamer Snare Probe 2.5MM X 230 (30MM, Oval, Monofilament Firm Loop) (Gastroscope/Colonoscope/Duodenoscopy)	5/case

Beamer Argon Probe

Latex **FREE**

Sterile, Disposable

Catalog Number	Description	Unit
A-Beam-1	Beamer Probe 1.8MM X 160CM (Bronchoscope)	10/case
A-Beam-2	Beamer Probe 1.8MM X 320CM (Enteroscope)	10/case
A-Beam-3	Beamer Probe 2.3MM X 230CM (Gastroscope/Colonoscope/Duodenoscopy)	10/case
A-Beam-4	Beamer Probe 2.3MM X 320CM (Enteroscope)	10/case
A-Beam-5	Beamer Probe 3.2MM X 230CM (Gastroscope/Colonoscope/Duodenoscopy)	10/case

Disposable Snares

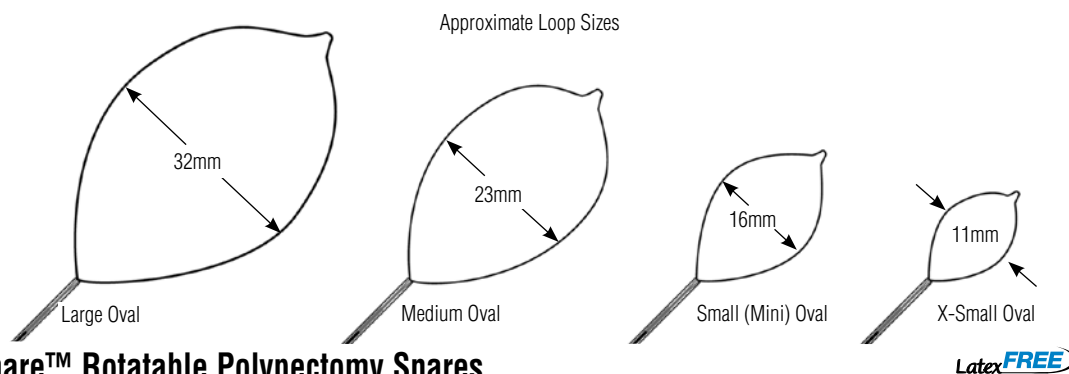

Orbit-Snare™ Rotatable Polypectomy Snares

Sterile, Disposable

Catalog Number	Loop			Sheath			Unit
	Size	Shape	Active Cord	O.D.	Length	Wire Type	
01-15-230	15mm	Rotatable Oval	Universal	2.5mm	230cm	Firm	10/box
01-25-230	25mm	Rotatable Oval	Universal	2.5mm	230cm	Firm	10/box
01-35-230	35mm	Rotatable Oval	Universal	2.5mm	230cm	Firm	10/box
02-25-230	25mm	Rotatable Hexagonal	Universal	2.5mm	230cm	Firm	10/box

Optimizer® Polypectomy Snares

Sterile, Disposable

Catalog Number	Loop			Sheath			Unit
	Size	Shape	Active Cord	O.D.	Length	Wire Type	
Firm Loop Wire							
000472	Large	Oval	Olympus	2.3mm	230cm	Firm	10/box
000473	Large	Oval	Microvasive	2.3mm	230cm	Firm	10/box
000474	Medium	Oval	Olympus	2.3mm	230cm	Firm	10/box
000475	Medium	Oval	Microvasive	2.3mm	230cm	Firm	10/box
000476	Small (Mini)	Oval	Olympus	2.3mm	230cm	Firm	10/box
000477	Small (Mini)	Oval	Microvasive	2.3mm	230cm	Firm	10/box
000478	X-Small	Oval	Olympus	2.3mm	230cm	Firm	10/box
000479	X-Small	Oval	Microvasive	2.3mm	230cm	Firm	10/box
Soft Loop Wire							
000460	Large	Oval	Olympus	2.3mm	230cm	Soft	10/box
000461	Large	Oval	Microvasive	2.3mm	230cm	Soft	10/box
000462	Medium	Oval	Olympus	2.3mm	230cm	Soft	10/box
000463	Medium	Oval	Microvasive	2.3mm	230cm	Soft	10/box
000464	Small (Mini)	Oval	Olympus	2.3mm	230cm	Soft	10/box
000465	Small (Mini)	Oval	Microvasive	2.3mm	230cm	Soft	10/box
000466	X-Small	Oval	Olympus	2.3mm	230cm	Soft	10/box
000467	X-Small	Oval	Microvasive	2.3mm	230cm	Soft	10/box

Active Cord

Non-Sterile, Reusable

Catalog Number	Active Cord
SN-UAC	Universal Monopolar Active Cord (Fits Olympus style electrode connector)

■ Disposable Snares

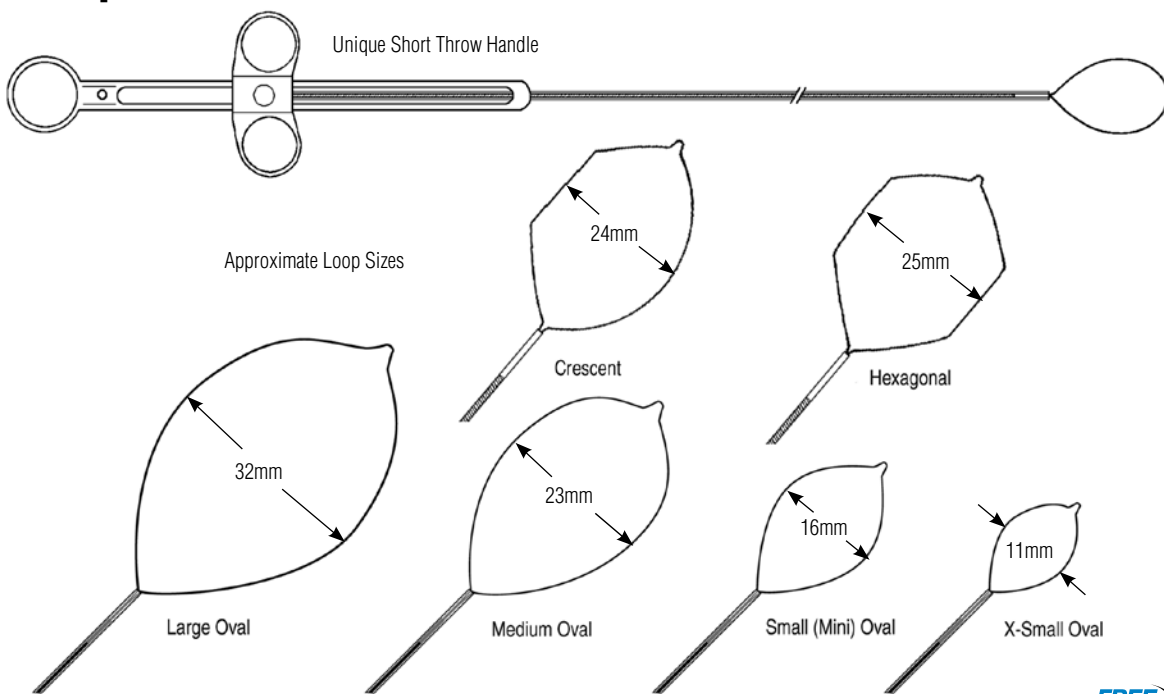

Singular™ Polypectomy Snares

Catalog Number	Loop		Active Cord	Sheath		Unit
	Size	Shape		O.D.	Length	
Sterile, Disposable						
Firm Loop Wire						
000957	Medium	Crescent	Olympus	2.3mm	230cm	10/box
000958	Medium	Crescent	Microvasive	2.3mm	230cm	10/box
000959	Medium	Hexagonal	Olympus	2.3mm	230cm	10/box
000960	Medium	Hexagonal	Microvasive	2.3mm	230cm	10/box
000963	Large	Oval	Olympus	2.3mm	230cm	10/box
000964	Large	Oval	Microvasive	2.3mm	230cm	10/box
000965	Medium	Oval	Olympus	2.3mm	230cm	10/box
000966	Medium	Oval	Microvasive	2.3mm	230cm	10/box
000978	Small (Mini)	Oval	Olympus	2.3mm	230cm	10/box
000979	Small (Mini)	Oval	Microvasive	2.3mm	230cm	10/box
000991	X-Small	Oval	Olympus	2.3mm	230cm	10/box
000992	X-Small	Oval	Microvasive	2.3mm	230cm	10/box
Soft Loop Wire						
000977	Large	Oval	Olympus	2.3mm	230cm	10/box
000980	Large	Oval	Microvasive	2.3mm	230cm	10/box
000983	Medium	Oval	Olympus	2.3mm	230cm	10/box
000984	Medium	Oval	Microvasive	2.3mm	230cm	10/box
000985	Small (Mini)	Oval	Olympus	2.3mm	230cm	10/box
000986	Small (Mini)	Oval	Microvasive	2.3mm	230cm	10/box
000987	X-Small	Oval	Olympus	2.3mm	230cm	10/box
000988	X-Small	Oval	Microvasive	2.3mm	230cm	10/box

■ Disposable Snares

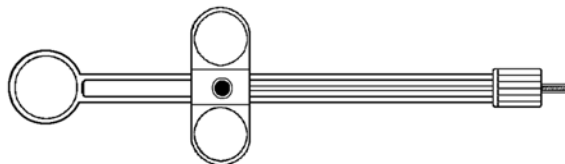

Disposable Snare Assembly To Fit Olympus® Handle

Latex **FREE**

Non-Sterile, Disposable

Catalog Number	Description	Shape	Sheath		Unit
			O.D.	Length	
000913	Snare Assembly	Oval	2.3mm	230cm	10/box

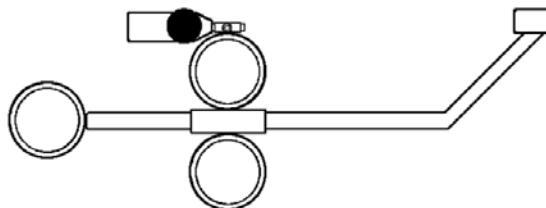

Disposable Snare Assembly To Fit Cameron-Miller™ Handle

Latex **FREE**

Non-Sterile, Disposable

Catalog Number	Description	Shape	Sheath		Unit
			O.D.	Length	
000916	Snare Assembly	Oval	2.3mm	230cm	10/box

Disposable Snare Assembly ConMed® Handle

Latex **FREE**

Non-Sterile, Disposable

Catalog Number	Description	Shape	Sheath		Unit
			O.D.	Length	
000908	Snare Assembly	Hexagonal	2.3mm	230cm	10/box
000909	Snare Assembly	Crescent	2.3mm	230cm	10/box
000910	Snare Assembly	Oval	2.3mm	230cm	10/box

ACCESSORIES

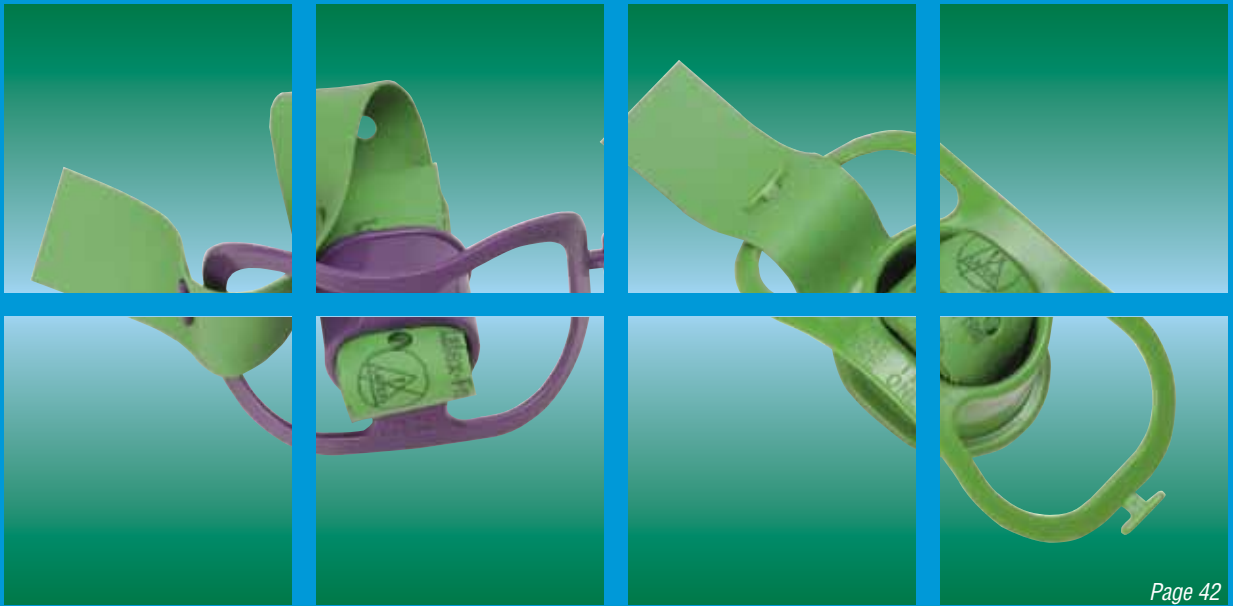

Page 42

Cleaning Brushes

<i>Channel Master™ Endoscope</i>	
<i>Cleaning Brushes</i>	41
<i>Whistle® Endoscope Cleaning Brush</i>	41
<i>Blue Bullet® Disposable Cleaning Brushes</i>	41
<i>Reusable Cleaning Brush</i>	41

Accessory Devices

<i>Scope Saver® Disposable Bite Blocks</i>	42
<i>Biopsy Channel Accessory Introducer</i>	42
<i>Bite Block</i>	42

Page 41

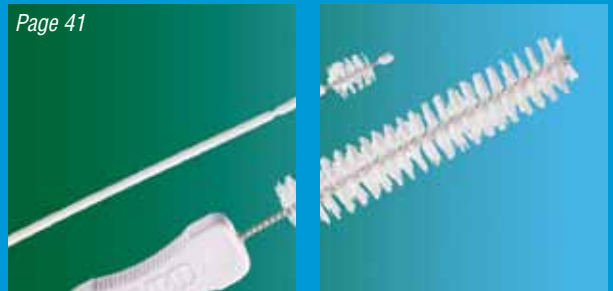

Page 41



ACCESSORIES

■ Cleaning Brushes

Rounded Brush Tip

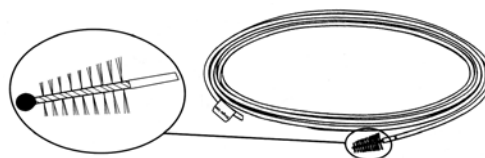

Channel Master™ Endoscope Cleaning Brushes

Latex **FREE**

Non-Sterile, Disposable – Biopsy Channel Range 2.0-2.4mm, Shaft O.D. 1.7mm

Catalog Number	Scope	Brush		Shaft	Unit
		Diameter	Length	Length	
000610	Pediatric Brush	6.4mm	7.4mm	160cm	50/box
000615	Dual-Ended Brush	6.4mm	7.4mm	230cm	50/box
000639	Single-Ended Brush	6.4mm	7.4 mm	230cm	50/box
000617	Combination Valve/Cleaning Brush for Gastroscope/Colonoscope	7.9mm/6.4mm	29.2mm/ 7.4mm	230cm	50/box
000619 *	Large Combination Valve/Cleaning Brush for Gastroscope/Colonoscope	9.7mm/6.4mm	45.2mm/ 7.4mm	230cm	50/box

* Large combination brush includes longer & larger diameter bristles on valve brush.

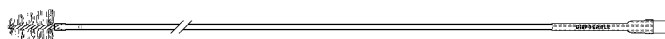

Whistle® Endoscope Cleaning Brush

Latex **FREE**

Non-Sterile, Disposable – Biopsy Channel Minimum 2.8mm, Shaft O.D. 1.8mm

Catalog Number	Scope	Brush		Shaft	Unit
		Diameter	Length	Length	
000101	Whistle® Cleaning Brush	6.4mm	13.1mm	230cm	50/box

Contains female luer adaptor, hollow shaft, and port hole for fluid injection to soften channel obstructions.



Blue Bullet® Disposable Cleaning Brushes

Latex **FREE**

Non-Sterile, Disposable

Catalog Number	Scope	Brush		Shaft	Unit
		Diameter	Length	Length	
473	Gastro/Duodeno/Colonoscope	3mm	13mm	250cm	50/box
474	Gastro/Duodeno/Colonoscope	4mm	13mm	250cm	50/box
478	Gastro/Duodeno/Colonoscope	5mm	13mm	250cm	50/box
476	Gastro/Duodeno/Colonoscope	6mm	13mm	250cm	50/box
478C	Combination Valve/Channel Cleaning Brush for Gastroscope/Colonoscope	10mm/5mm	38mm/13mm	250cm	50/box
478D	Double End Cleaning Brush for Gastroscope/Colonoscope	5mm	13mm	250cm	50/box

The 400 series Blue Bullet® feature a blue opaque tubing.



Reusable Cleaning Brush

Latex **FREE**

Non-Sterile, Reusable

Catalog Number	Scope	Brush		Shaft	Unit
		Diameter	Length	Length	
378	Gastro/Duodeno/Colonoscope	6mm	9.5mm	230cm	1/box

The reusable scope cleaning brush features a controllable ring handle and a Teflon® coated spring sheath.

Accessory Devices

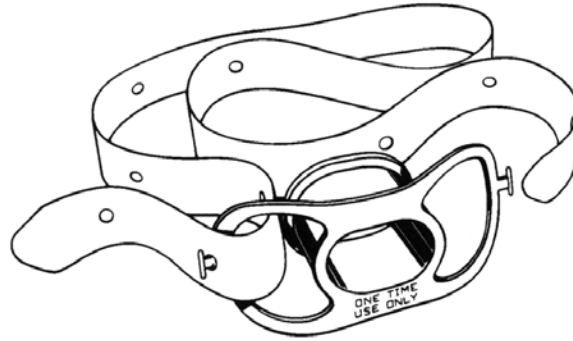

Scope Saver® Disposable Bite Blocks

Latex **FREE**

Non-sterile

Catalog Number	Description	Lumen Size	Color	Unit
000429 [◇]	Large Scope Saver® Disposable Latex Free Bite Block	20 x 27mm	Green	50/box
100429	Small Scope Saver® Disposable Latex Free Bite Block	14 x 20mm	Purple	25/box

[◇] Accommodates up to a 60 F American Dilator

Biopsy Channel Accessory Introducer

Latex **FREE**

Non-sterile, Disposable

Catalog Number	Description	Unit
000160	Accessory Introducer	6/box



Bite Block

Latex **FREE**

Non-sterile, Disposable

Catalog Number	Description	Unit
CD120	Large Bite Block w/ Tongue Depressor	50/box

PULMONARY

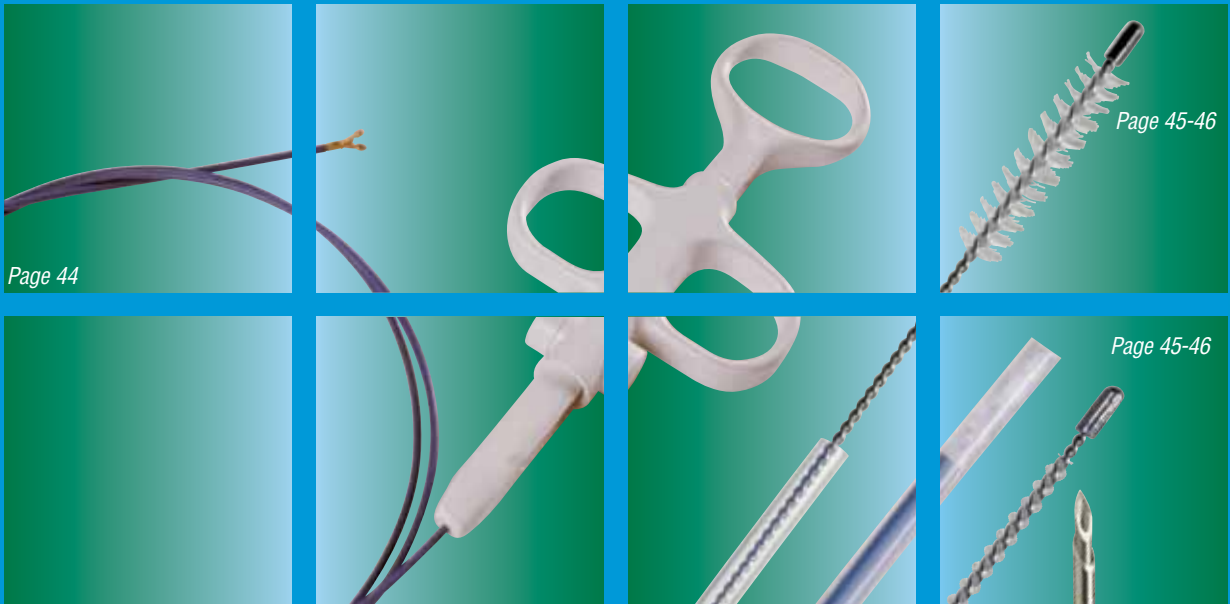

Transbronchial Aspiration Needles

- WANG® Cytology Needles 43
- WANG® Histology Needles 43

Biopsy Forceps

- Precisor Broncho® 44
- Disposable Biopsy Forceps 44

Brushes

- Cytology Brushes 45
- Needle Tip and Peripheral Cytology Brushes 46
- Microbiology Brush 46

Kits and Accessories

- WANG® Pleural Tapping Needle 47
- GARG™ Thoracentesis Needle and Kit 48

Cleaning Brushes

- Blue Bullet® Disposable Cleaning Brush 49
- Channel Master™ Endoscope Cleaning Brush 49
- Reusable Cleaning Brush 49

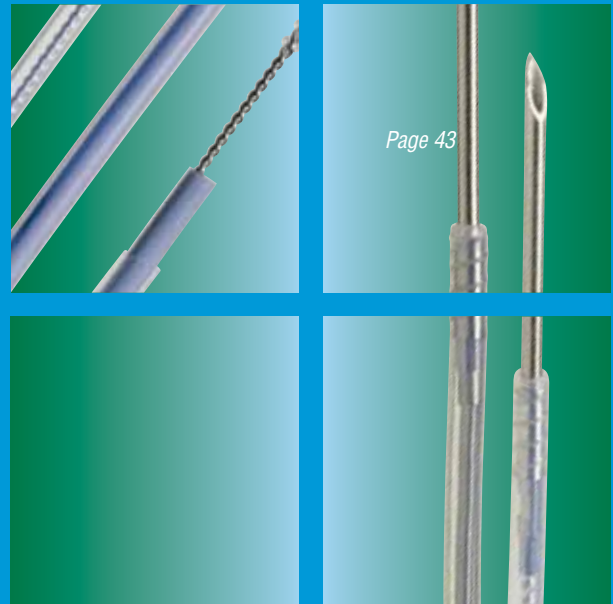

PULMONARY

■ Transbronchial Aspiration Needles

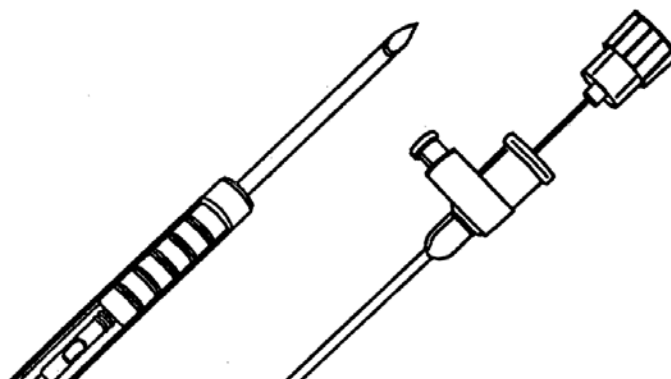

WANG® Cytology Needles

Latex **FREE**

Sterile, Disposable

Catalog Number	Biopsy Site	Needle		Unit
		Gauge	Length	
MW-122	Central, Carinal and Mediastinal Regions	22 g	13mm	4/box
MW-222	Central or Peripheral Regions	22 g	13mm	4/box
MW-322	Central, Mediastinal and Hilar Regions	22 g	13mm	4/box
MW-522	Peripheral Region	22 g	13mm	4/box
SW-121	Central, Carinal and Mediastinal Regions	21 g	15mm	4/box
SW-221	Central or Peripheral Regions	21 g	15mm	4/box
SW-521	Peripheral Region	21 g	15mm	4/box
W-220	Central or Peripheral Regions	20 g	15mm	4/box

All WANG® needles have a 1.9mm working diameter and a 140cm working length.

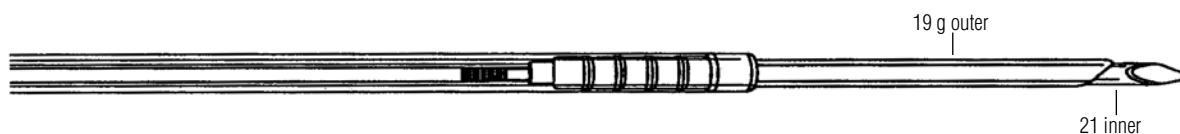

WANG® Histology Needles

Latex **FREE**

Sterile, Disposable

Catalog Number	Biopsy Site	Needle		Unit
		Gauge	Length	
MW-319	Central and Mediastinal Regions	inner - 21 g	3mm	4/box
		outer - 19 g	15mm	
MWF-319	Peripheral Region	19 g	15mm	4/box

All WANG® needles have a 1.9mm working diameter and a 140cm working length.

PULMONARY

■ Biopsy Forceps

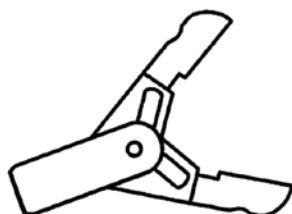

Oval Cup

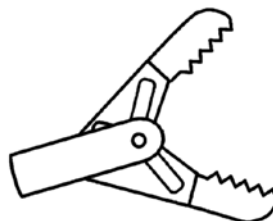

Alligator Cup

Precisor Broncho® Disposable Biopsy Forceps

Latex **FREE**

Sterile, Disposable

Catalog Number	Description	Shaft Length	Jaw O.D.	Unit
100502	Oval Cup Forceps/Channel-Guard™ Coated Shaft	115cm	1.8mm	10/box
100503	Alligator Cup Forceps/Channel-Guard™ Coated Shaft	115cm	1.8mm	10/box
100506	Oval Cup Forceps	115cm	1.8mm	10/box
100507	Alligator Cup Forceps	115cm	1.8mm	10/box

Brushes

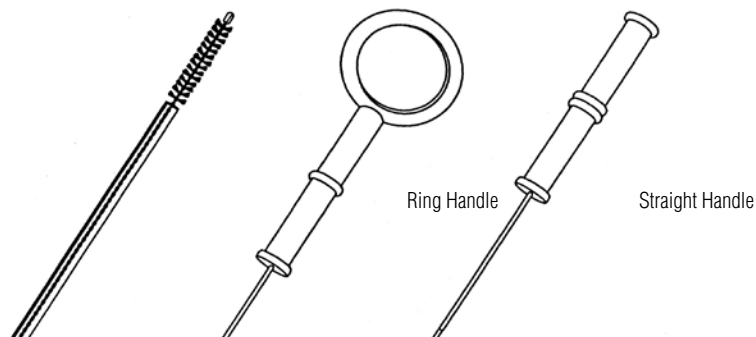

Cytology Brushes

Latex **FREE**

Sterile, Disposable

Catalog Number	Description	Brush Diameter	Length	Sheath		Unit
				Length	Diameter	
133	Straight Handle	1mm	120cm	1.7mm		20/box
133R	Ring Handle	1mm	120cm	1.7mm		20/box
129	Straight Handle	2mm	120cm	1.7mm		20/box
129R	Ring Handle	2mm	120cm	1.7mm		20/box
149	Straight Handle	3mm	120cm	1.7mm		20/box
149R	Ring Handle	3mm	120cm	1.7mm		20/box

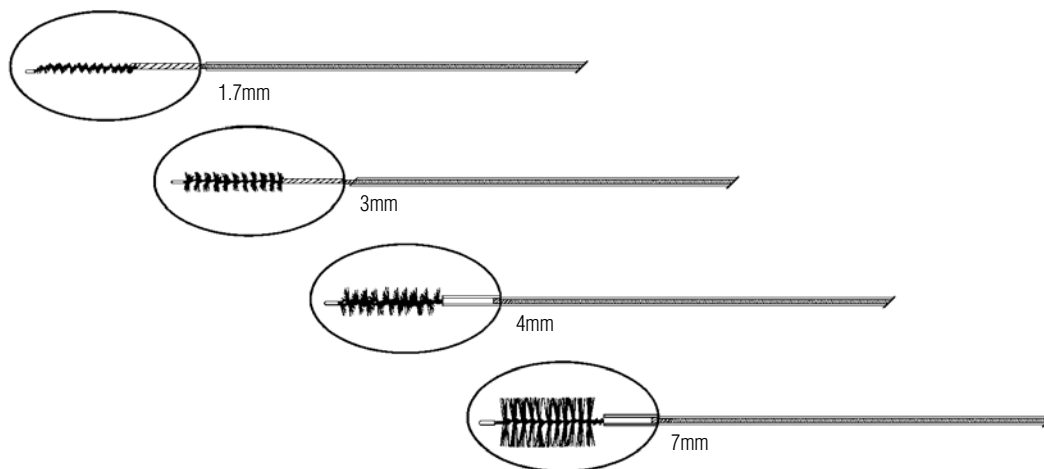

Catalog Number	Description	Scope	Brush Diameter	Length	Sheath		Unit
					Length	Diameter	
000104	Sheathed	Multi-Purpose	1.7mm	160cm	1.7mm		20/box
000107	Sheathed	Bronchoscope	3.0mm	115cm	1.7mm		20/box
000139	Harrell™ (unsheathed)	Bronchoscope	4.0mm	110cm	1.7mm		20/box
000140	Harrell™ (unsheathed)	Bronchoscope	7.0mm	110cm	1.2mm		20/box

PULMONARY

Brushes

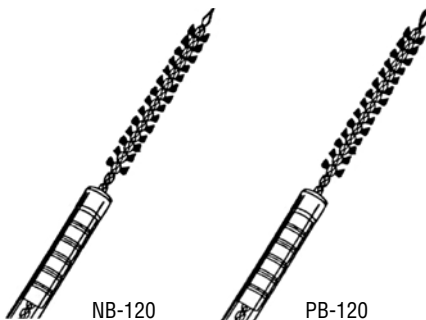

Needle Tip and Peripheral Cytology Brushes

Latex **FREE**

Sterile, Disposable

Catalog Number	Description	Brush Diameter	Length	Sheath		Unit
				Diameter	Length	
NB-120 *	Needle Tip Cytology Brush	1.7mm	11mm	1.9mm	140cm	4/box
PB-120 ◊	Peripheral Radiopaque Tip Cytology Brush	1.7mm	11mm	1.9mm	140cm	4/box

* Needle tip cytology brush is used for retrieving cytology specimens from endobronchial lesions, peripheral lung nodules, or lung masses.

◊ The metal tipped sheath of the peripheral brush allows for flourescopic visualization during cytologic collection.

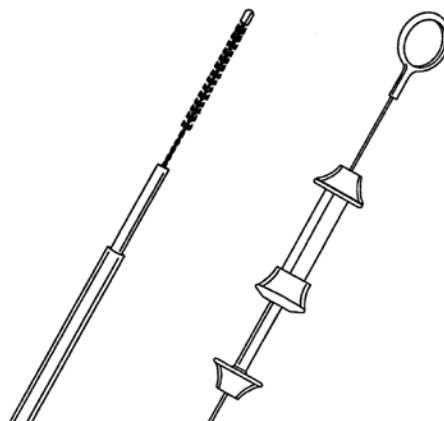

Microbiology Brush

Latex **FREE**

Sterile, Disposable

Catalog Number	Description	Brush Diameter	Length	Sheath		Unit
				Diameter		
130	Microbiology Brush	1mm	110cm	1.8mm		5/box

Designed to obtain contamination free specimens, the brush is protected behind a wax plug which is expelled before sampling.

■ Kits and Accessories



WANG® Pleural Tapping Needle

Latex **FREE**

Sterile, Disposable

Catalog Number	Description	Needle Gauge	Sheath		Unit
			Diameter	Length	
PTN 1780	WANG® Pleural Tapping Needle	17 g	2.3mm	8cm	5/box
KIT 1780 *	WANG® Pleural Tapping Needle with Procedural Kit				5/Box

*** Each WANG® Pleural Tapping Needle Kit Includes:**

- | | |
|-----------------------------------|-----------------------------------|
| 2 ea. 1" x 3" Adhesive bandage | 1 ea. 18 Gauge needle assembly |
| 1 ea. 18" x 26" Fenestrated drape | 3 ea. 8 ml Screw cap sterile vial |
| 4 ea. 4" x 4" Gauze pad | 1 ea. 20" Tube set |
| 1 ea. Iodophor PVP swabstick | 1 ea. 36" Extention line |
| 1 ea. Alcohol swabstick | 1 ea. Mini scalpel |
| 1 ea. 25 Gauge 3 cc syringe | 1 ea. 60 cc Luer lock syringe |
| 1 ea. 22 Gauge Luer lock needle | 1 ea. 10 cc Luer lock syringe |
| 1 ea. Luer slip check valve | 1 ea. 5 ml Xylocaine ampule |
| 1 ea. PTN-1780 needle | |

Kits and Accessories

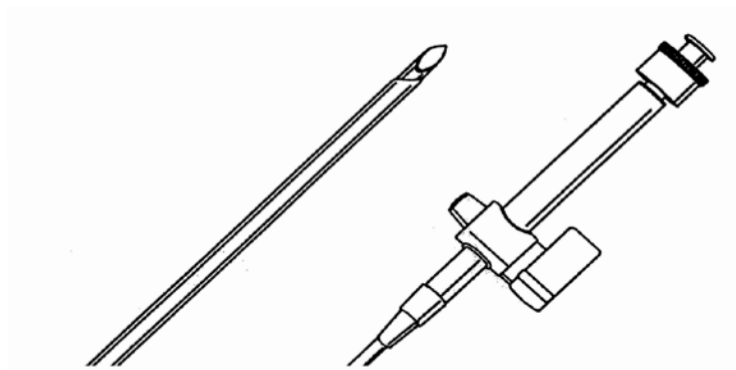

GARG™ Thoracentesis Needle and Kit

Latex **FREE**

Sterile, Disposable

Catalog Number	Description	Needle Gauge	Sheath		Unit
			Diameter	Length	
THR 1720	GARG™ Thoracentesis Needle	17 g	2.3mm	8cm	5/box
KIT 1720 *	GARG™ Thoracentesis Needle with Procedural Kit				5/box

*** Each GARG™ Thoracentesis Kit Includes:**

- | | |
|-----------------------------------|------------------------------------|
| 1 ea. Transparent dressing | 1 ea. 18 Gauge needle assembly |
| 1 ea. 18" x 26" Fenestrated drape | 3 ea. 18 ml Screw cap sterile vial |
| 4 ea. 4" x 4" Gauze pad | 1 ea. 36" Extension line |
| 1 ea. Iodophor PVP swabstick | 1 ea. 25 Gauge 3 cc syringe |
| 1 ea. Mini scalpel | 1 ea. 22 Gauge Luer lock needle |
| 1 ea. 5 ml Xylocaine ampule | 1 ea. 60 cc Luer lock syringe |
| 1 ea. THR-1720 needle | 1 ea. 10 cc Luer lock syringe |

■ Cleaning Brushes



Blue Bullet® Disposable Cleaning Brush

Latex **FREE**

Non-Sterile, Disposable

Brush					
Catalog Number	Scope	Diameter	Length	Shaft Length	Unit
480	Bronchoscope	3mm	13mm	115cm	50/box

The 400 series Blue Bullet® features a blue opaque tubing.

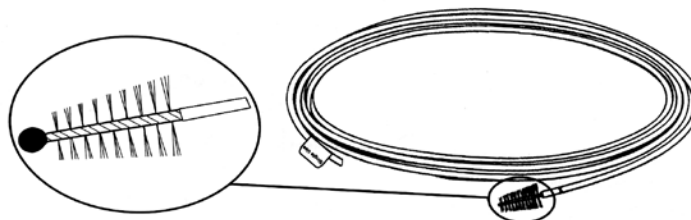

Rounded Brush Tip

Channel Master™ Endoscope Cleaning Brush

Latex **FREE**

Non-Sterile, Disposable

Catalog Number	Scope	Biopsy Channel Range	Shaft Length	Unit
000610	Bronchoscope	2.0 - 4.2mm	160cm	50/box *

* 2-box minimum order

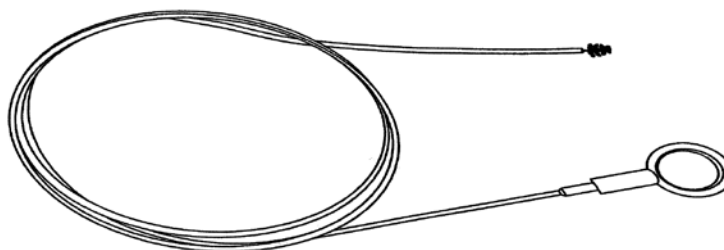

Reusable Cleaning Brush

Latex **FREE**

Non-Sterile

Brush					
Catalog Number	Scope	Diameter	Length	Shaft Length	Unit
380	Bronchoscope	3mm	9.5mm	115cm	1/box

The reusable scope cleaning brush features a controllable ring handle and a Teflon® coated spring sheath.

PULMONARY

GENERATORS



Generators	
Beamer® System CE600	51
Beamer™ Irrigation Pump	51
Accessories for Beamer™ Irrigation Pump	51
Beamer™ Argon Snare Probe	52
Beamer™ Argon Probe	52

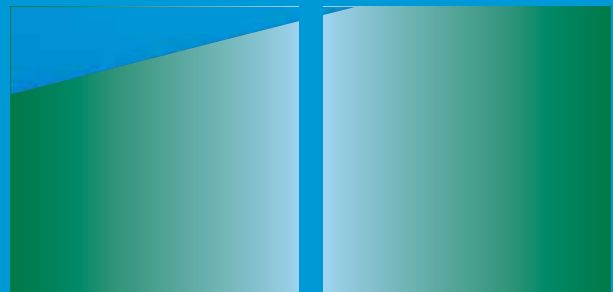

GENERATORS

Generators



Beamer® System CE600

Catalog Number	Description
CE200	Beamer Mate
CB200	Beamer Plus
CC200	Beamer Cart
CE200-A01	Double Foot Pedal with Foot Lift Bar
CB200-A01	Beamer Connecting Cable for Argon Probes

Beamer™ Irrigation Pump

Latex **FREE**

Catalog Number	Description	Unit
CETEGP-100	Irrigation Pump for Endoscopy Fits on Beamer™ Cart with Beamer System CE600 or as a Stand Alone Irrigation System	1/Box

Each CETEGP-100 includes:

- 1 ea Foot Switch
- 1 ea Power Cord
- 1 ea Bottle Holder
- 1 ea Pump Head

Accessories for Beamer™ Irrigation Pump

Latex **FREE**

Catalog Number	Description	Unit
CET230	Beamer Pump Tubing Set	10/Box
CETEGP-014	Replacement Pump Head	1/Box
CETEGP-009	Replacement Foot Switch	1/Box
CETEGP-012	Replacement Power Cord	1/Box
CET270	Replacement Bottle Holder	1/Box

Generators

Beamer™ Argon Snare Probe

Latex **FREE**

Sterile, Disposable

Catalog Number	Description	Unit
Beamsnare-1	Beamer Snare Probe 2.5MM X 160 (15MM, Firm Spiral Braided Oval Loop) (Bronchoscope)	5/case
Beamsnare-2	Beamer Snare Probe 2.5MM X 230 (15MM, Firm Spiral Braided Oval Loop) (Gastroscope/Colonoscope/Duodenoscope)	5/case
Beamsnare-3	Beamer Snare Probe 2.5MM X 230 (30MM, Firm Spiral Braided Oval Loop) (Gastroscope/Colonoscope/Duodenoscope)	5/case
Beamsnare-4	Beamer Snare Probe 2.5MM X 230 (15MM, Oval, Monofilament Firm Loop) (Gastroscope/Colonoscope/Duodenoscope)	5/case
Beamsnare-5	Beamer Snare Probe 2.5MM X 230 (30MM, Oval, Monofilament Firm Loop) (Gastroscope/Colonoscope/Duodenoscope)	5/case

Beamer™ Argon Probe

Latex **FREE**

Sterile, Disposable

Catalog Number	Description	Unit
A-Beam-1	Beamer Probe 1.8MM X 160CM (Bronchoscope)	10/case
A-Beam-2	Beamer Probe 1.8MM X 320CM (Enteroscope)	10/case
A-Beam-3	Beamer Probe 2.3MM X 230CM (Gastroscope/Colonoscope/Duodenoscope)	10/case
A-Beam-4	Beamer Probe 2.3MM X 320CM (Enteroscope)	10/case
A-Beam-5	Beamer Probe 3.2MM X 230CM (Gastroscope/Colonoscope/Duodenoscope)	10/case

LATEX PRODUCTS

Latex Products

53

LATEX PRODUCTS

Applied Ingenuity™



Please be advised that the following devices or components provided by ConMed Endoscopic Technologies® contain natural rubber latex, which may cause allergic reactions in some individuals:

Product	Catalog Number	Device/Component
Stiegmann-Goff™ Endoscopic Ligator Kit	000221, 000227, 200220-221	"O" ring contains latex
Stiegmann-Goff™ Bandito™ Endoscopic Ligator	100225-226	"O" ring contains latex
DuraGlide3™ Stone Removal Balloon	007123-007125, 007143-007145	Latex balloon
DuraGlide™ Stone Removal Balloon	000635, 000637-638, 000646-647	Latex balloon
Disposable Percutaneous Biopsy Instruments	000402, 000439, 000441	Syringe Plunger
Auto-Band Ligator	SABLU6L, SABLU6VL, SABLU8L, SABLU8LV, SABLA6CGL, SABLA6VCGL, SABLA5CL, SABLA5SVCL	Rubber band contains latex

CATALOG INDEX



CATALOG INDEX

Applied Ingenuity™



<u>Catalog Number</u>	<u>Page</u>	<u>Catalog Number</u>	<u>Page</u>	<u>Catalog Number</u>	<u>Page</u>
000101	41	000385	29	000854	31
000104	33, 45	000386	29	000856	31
000107	45	000388	29	000857	19
000108	33	000389	29	000858	19
000109	33	000402	32	000859	19
000110	33	000429	42	000861	19
000138	24	000439	32	000867	19
000139	45	000441	32	000908	40
000140	45	000443	19	000909	40
000150	20	000460	38	000910	40
000156	7	000461	38	000913	40
000160	42	000462	38	000916	40
000183	7	000463	38	000957	39
000196	33	000464	38	000958	39
000198	24	000465	38	000959	39
000199	24	000466	38	000960	39
000200	24	000467	38	000963	39
000215	24	000472	38	000964	39
000216	24	000473	38	000965	39
000217	24	000474	38	000966	39
000218	24	000475	38	000977	39
000221	22	000476	38	000978	39
000227	22	000477	38	000979	39
00230A	37	000478	38	000980	39
000249	20	000479	38	000983	39
000250	20	000560	5	000984	39
000270	20	000610	41, 49	000985	39
000271	20	000615	41	000986	39
000272	20	000617	41	000987	39
000273	20	000619	41	000988	39
000274	20	000635	8	000991	39
000275	20	000637	8	000992	39
000277	20	000638	8	00704P	13
000278	20	000639	41	00705A	10
000279	20	000646	8	00705C	12
000280	20	000647	8	00705S	11
000281	20	000735	19	00707A	10
000288	20	000736	19	00707C	12
000289	20	000816	30	00707P	13
000290	20	000817	30	00707S	11
000291	20	000818	30	00709A	10
000336	20	000819	30	00709C	12
000337	20	000820	30	007100	4
000340	19	000821	30	00710P	13
000341	19	000822	30	00710S	11
000342	19	000823	30	007101	4
000343	19	000837	30	007102	4
000344	19	000838	30	007103	4
000345	19	000840	30	007104	3
000347	9	000841	30	007105	3
000348	9	000844	19	007106	3
000349	9	000845	19	007107	3
000379	19	000846	19	00712A	10
000380	19	000847	19	00712C	12
000381	29	000848	19	007123	8
000382	29	000849	19	007124	8
000383	29	000852	31	007125	8
000384	29	000853	31	007143	8

CATALOG NUMBER INDEX

Catalog Number	Page	Catalog Number	Page	Catalog Number	Page
007144.....	8	035450SS.....	6	100571.....	29
007145.....	8	04-23-180.....	24	100572.....	29
00715A.....	10	04-23-230.....	24	100573.....	29
00715C.....	12	050053.....	4	100574.....	29
00820C.....	29	050054.....	4	100575.....	29
00821C.....	29	050063.....	4	100576.....	29
00822C.....	29	050064.....	4	100577.....	29
00823C.....	29	050071.....	3	100578.....	29
01004P.....	13	050073.....	3	1006L.....	10 – 13
01005A.....	10	050300.....	7	1007AK.....	10
01005C.....	12	050310.....	7	1007CK.....	12
01005S.....	11	050315.....	7	1007PK.....	13
01007A.....	10	050320.....	7	1007SK.....	11
01007C.....	12	050325.....	7	100851.....	19
01007P.....	13	050330.....	7	1009AK.....	10
01007S.....	11	050370.....	7	1009CK.....	12
01009A.....	10	050906.....	7	1010PK.....	13
01009C.....	12	050907.....	7	1010SK.....	11
01010P.....	13	05-19-180.....	24	1012AK.....	10
01010S.....	11	05-19-230.....	24	1012CK.....	12
01012A.....	10	06-19-180.....	24	1015AK.....	10
01012C.....	12	06-19-230.....	24	1015CK.....	12
01015A.....	10	0700G.....	10 – 13	1205AK.....	10
01015C.....	12	0704PK.....	13	1205CK.....	12
01-15-230.....	38	0705AK.....	10	1205SK.....	11
01-19-180.....	24	0705CK.....	12	1206L.....	10 – 13
01-19-230.....	24	0705SK.....	11	1207AK.....	10
01205A.....	10	0707AK.....	10	1207CK.....	12
01205C.....	12	0707CK.....	12	1207SK.....	11
01205S.....	11	0707PK.....	13	1209AK.....	10
01207A.....	10	0707SK.....	11	1209CK.....	12
01207C.....	12	0709AK.....	10	1210SK.....	11
01207S.....	11	0709CK.....	12	1212AK.....	10
01209A.....	10	0710PK.....	13	1212CK.....	12
01209C.....	12	0710SK.....	11	1215AK.....	10
01210S.....	11	0712AK.....	10	1215CK.....	12
01212A.....	10	0712CK.....	12	129.....	45
01212C.....	12	0715AK.....	10	129R.....	45
01215A.....	10	0715CK.....	12	130.....	46
01215C.....	12	100218.....	24	133.....	45
0160MG.....	37	100225.....	23	133R.....	45
01-25-230.....	38	100226.....	23	133001.....	26
01-35-230.....	38	1004PK.....	13	133002.....	26
02-23-180.....	24	100429.....	42	149.....	45
02-23-230.....	24, 38	1005AK.....	10	149R.....	45
0230AM.....	37	1005CK.....	12	151.....	33
025260S.....	6	1005SK.....	11	151R.....	33
025450A.....	6	100502.....	31, 44	152.....	33
025450S.....	6	100503.....	31	152R.....	33
03-19-180.....	24	100503.....	44	158.....	33
03-19-230.....	24	100506.....	31	158R.....	33
035260A.....	6	100506.....	44	163.....	33
035260AS.....	6	100507.....	31	163R.....	33
035260S.....	6	100507.....	44	378.....	41
035260SS.....	6	100512.....	30	380.....	49
035450A.....	6	100513.....	30	200220.....	22
035450AS.....	6	100516.....	30	200221.....	22
035450S.....	6	100517.....	30	473.....	41

Catalog Number	Page	Catalog Number	Page	Catalog Number	Page
474	41	FESG1800	35	RMGB2000	36
476	41	FESG2000	35	RMGB2400	36
478	41	FESG2400	35	SABLA5C	21
478C	41	FESP1400	35	SABLA5CL	21
478D	41	FESP1800	35	SABLA5VC	21
480	49	FESP2000	35	SABLA5VCL	21
7100AC	4	FESP2400	35	SABLA6CGL	21
7101AC	4	FEXG1400	35	SABLA6VCGL	21
7104AC	3	FEXG1800	35	SABLU6L	21
7105AC	3	FEXG2000	35	SABLU6VL	21
A-Beam-1	25, 37, 52	FEXG2400	35	SABLU7	21
A-Beam-2	25, 37, 52	FEXP1400	35	SABLU7V	21
A-Beam-3	25, 37, 52	FEXP1800	35	SABLU8L	21
A-Beam-4	25, 37, 52	FEXP2000	35	SABLU8VL	21
A-Beam-5	25, 37, 52	FEXP2400	35	SABLU10	21
AX4535	3	FX35260A	5	SABLU10V	21
Beamsnare-1	25, 37, 52	FX35260S	5	SN-UAC	38
Beamsnare-2	25, 37, 52	FX35450A	5	SW-121	43
Beamsnare-3	25, 37, 52	FX35450S	5	SW-221	43
Beamsnare-4	25, 37, 52	KIT 1720	48	SW-521	43
Beamsnare-5	25, 37, 52	KIT 1780	47	THR 1720	48
BP-5200A	25	LXB08040	15	US1822EB	17
BP-7300A	25	LXB08060	15	US1822R	17
BP-7350A	25	LXB08080	15	US1825R	17
BP-7350S	25	LXB08100	15	US2119R	17
BP-10300A	25	LXB10040	15	US2722R	17
CB200	27, 51	LXB10060	15	US2725R	17
CB200-A01	27, 51	LXB10080	15	VH0806200	14
CC200	27, 51	LXB10100	15	VH0808200	14
CD120	42	MW-122	43	VH0810200	14
CE200	27, 51	MW-222	43	VH1006200	14
CE200-A01	27, 51	MW-319	43	VH1008200	14
CET230	27, 51	MW-322	43	VH1010200	14
CET270	27, 51	MW-522	43	VN0804200	14
CETEGP-009	27, 51	MWF-319	43	VN0806200	14
CETEGP-012	27, 51	NB-120	46	VN0808200	14
CETEGP-014	27, 51	PB-120	46	VN0810200	14
CETEGP-100	27, 51	PTN 1780	47	VN1004200	14
FEAC1400	35	RBJG0900	36	VN1006200	14
FEAC2000	35	RBJG1200	36	VN1008200	14
FEDP1400	35	RBJP0900	36	VN1010200	14
FEDP1820	35	RBJP1200	36	W-220	43
FEDP2400	35	RMGB1400	36		
FESG1400	35	RMGB1800	36		

Prior to use consult product insert for indications, contra-indications, instructions for use, warnings and precautions.

Boston Scientific Endoscopy and Endostat are trademarks of Boston Scientific Corporation

Cameron-Miller is a trademark of Cameron-Miller, Inc.

Erbe is a trademark of Erbe GmbH Corporation

Force 2 is a trademark of Tyco Healthcare Group, LP or an affiliate

Force FX is a trademark of ValleyLab Corporation

Monopty is a registered trademark of C.R. Bard, Inc.

Olympus is a registered trademark of Olympus America, Inc.

Wang is a trademark licensed to ConMed Corporation

Teflon is a registered trademark of DuPont

ValleyLab is a registered trademark of ValleyLab Corporation

Viabil is a registered trademark of W.L. Gore & Associates

BILIARY

ENDOSCOPIC ULTRASOUND

DILATION

HEMOSTASIS

BIOPSY

GASTROSTOMY

POLYPECTOMY

ACCESSORIES

PULMONARY

LATEX PRODUCTS

CATALOG INDEX



CONMED CORPORATION PRODUCT AREAS:

ARTHROSCOPY • ELECTROSURGERY • ENDOSCOPY • ENDOSURGERY • GASTROENTEROLOGY • INTEGRATED SYSTEMS • PATIENT CARE • POWERED INSTRUMENTS • PULMONOLOGY



525 French Road
Utica, NY 13502
(315) 797-8375
Customer Service: 1-800-448-6506
FAX: 1-800-438-3051
International Sales: +1(315) 797-8375 • FAX: +1(315) 735-6235
email: info@mail.conmed.com
www.conmed.com